

STORMWATER POLLUTION PREVENTION, GRADING, AND EROSION CONTROL

Best Management Practices Manual

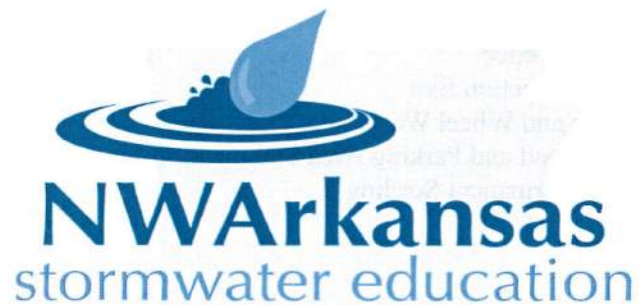

Revised April 2014

Table of Contents

Table of Contents	ii
Figures & Tables	iv
Executive Summary	v
Glossary	vi
Introduction to Construction Stormwater Pollution Prevention	viii
Standards and Specifications for Best Management Practices	x
Chapter 1: Prevention BMPs	
BMP 101: Preserving Natural Vegetation	1 of 16
BMP 102: Buffer Zones	2 of 16
BMP 103: Wetland Preservation, Creation, and Re-creation	3 of 16
BMP 104: Floodway and Floodplain	3 of 16
BMP 105: Watershed vs. Site Drainage	4 of 16
BMP 110: Dust Prevention and Control	5 of 16
BMP 120: Kits and Containment Materials	7 of 16
BMP 121: Material Delivery	8 of 16
BMP 122: Material Storage	9 of 16
BMP 123: Material Containment	10 of 16
BMP 124: Concrete Handling	11 of 16
BMP 125: Saw-Cutting and Surfacing Pollution Prevention	12 of 16
BMP 130: Gross Solids and Solid Waste	12 of 16
BMP 131: Sanitary Service	13 of 16
BMP 132: Washouts	13 of 16
BMP 140: Qualified Site Official (QSO)	14 of 16
BMP 150: Scheduling and Sequencing	15 of 16
BMP 170: Storm Water Pollution Prevention Plans	15 of 16
Chapter 2: Access and Source Control BMPs	
BMP 201: High Visibility Fence	1 of 22
BMP 202: Stake and Wire Fence	1 of 22
BMP 210: Stabilized Construction Exit	2 of 22
BMP 211: Rumble Strips and Wheel Wash	4 of 22
BMP 212: Construction Road and Parking Area Stabilization	6 of 22
BMP 220: Temporary & Permanent Seeding	7 of 22
BMP 221: Mulching	10 of 22
BMP 230: Nets & Blankets	11 of 22
BMP 240: Sodding	14 of 22
BMP 241: Top-soiling	15 of 22
BMP 250: PAM for Soil Erosion Protection	16 of 22
BMP 260: Surface Roughening	19 of 22
BMP 261: Gradient Terrace	20 of 22

Chapter 3: Conveyance BMPs

BMP 301: Interceptor Dike and Swale	1 of 29
BMP 302: Grass-Lined Channel	2 of 29
BMP 303: Reinforced Channel Lining	5 of 29
BMP 304: Vegetated Strip	6 of 29
BMP 310: Diversionary Ditch	7 of 29
BMP 311: Pipe-Slope Drain	8 of 29
BMP 312: Subsurface Drain	10 of 29
BMP 313: Level Spreader	11 of 29
BMP 320: Waddles or Wattles	12 of 29
BMP 321: Check Dam	14 of 29
BMP 322: Geo-textile Encased Check Dam	16 of 29
BMP 323: Brush Barrier	17 of 29
BMP 324: Gravel Filter Berm	18 of 29
BMP 330: Storm Drain Inlet Protection	18 of 29
BMP 340: Outlet Protection	22 of 29
BMP 341: Energy Dissipaters	23 of 29
BMP 350: Square Grain Barrier	24 of 29
BMP 351: Embedded Reinforced Perimeter Sediment Barrier	25 of 29

Chapter 4: Treatment BMPs

BMP 401: Sediment Trap	1 of 12
BMP 402: Temporary Sediment Pond	3 of 12
BMP 410: Retention/Detention Pond	6 of 12
BMP 420: De-watering	7 of 12
BMP 421: Turbidity Removal	7 of 12
BMP 430: Chemical Treatments	8 of 12
BMP 440: Filtration	11 of 12

Appendixes

Appendix A: Planning	A-1
Appendix B: Low Impact Development	B-1
Appendix C: Standard Comments for ESC Plans	C-1
Appendix D: Information on Chemical Treatments	D-1
Appendix E: Construction SWPPP Checklist	E-1
Appendix F: Minimum Requirements for Training Course	F-1

Figures

Figure 2.1	Stake and Wire Fence	2-2
Figure 2.2	Stabilized Construction Exit with Sediment Trap	2-3
Figure 2.3	Wheel Wash	2-6
Figure 2.4	Slope Installations of Nets and Blankets	2-12
Figure 2.5	Channel Installations of Nets and Blankets	2-13
Figure 2.6	Surface Roughening by Tracking and Contour Furrows	2-20
Figure 2.7	Gradient Terrace	2-21
Figure 3.1	Typical Grass-Lined Channels	3-3
Figure 3.2	Trapezoidal Channel Liners	3-4
Figure 3.3	Pipe-Slope Drains	3-8
Figure 3.4	Cross Section of Level Spreader	3-12
Figure 3.5	Detail of Level Spreader	3-12
Figure 3.6	Straw Wattles	3-13
Figure 3.7	Check Dam	3-15
Figure 3.8	Brush Barrier	3-17
Figure 3.9	Block and Gravel Filter	3-20
Figure 3.10	Catch Basin Filter	3-21
Figure 3.11	Curb and Gutter Sediment Trap (or "J" Hook)	3-22
Figure 3.12	Square Grain Barriers	3-25
Figure 3.13	Reinforced Perimeter Sediment Barriers	3-26
Figure 3.14	Reinforced Perimeter Sediment Barriers by Slicing Method	3-28
Figure 4.1	Cross Section of Sediment Trap	4-2
Figure 4.2	Sediment Trap Outlets	4-2
Figure 4.3	Sediment Pond Plan View	4-3
Figure 4.4	Sediment Pond Cross Section	4-4
Figure 4.5	Sediment Pond Riser Detail	4-4
Figure 4.6	Riser Inflow Curves	4-5

Tables

Table 1	On-Hand Containment Materials	1-8
Table 2	Geo-Textile Standards for Construction Exit Pads	2-2
Table 3	Wet Area Seed Mix	2-9
Table 4	Meadow Seed Mix	2-9
Table 5	Mulch Standards and Guidelines	2-10
Table 6	PAM and Water Application Rates	2-17
Table 7	Interceptor Dike Criteria	3-1
Table 8	Interceptor Swale Criteria	3-2
Table 9	Vegetative Strip	3-6
Table 10	Diversionary Ditch Spacing Guidelines	3-7
Table 11	Storm Drain Inlet Protection	3-19
Table 12	Geo-Textile Standards for Embedded Reinforced Perimeter Sediment Barriers	3-26

Stormwater Management Manual for Construction Stormwater Pollution Prevention

Executive Summary

Prepared by the Stormwater Compliance Group of Northwest Arkansas

This manual was written for the small Municipal Separate Stormwater Sewer Systems (MS4s) in Northwest Arkansas to serve as a common guidance document for the design and implementation of control measures for construction site runoff control and post-construction runoff controls. It was proposed by members of the NWA Stormwater Focus Team that this document should be used by MS4 jurisdictions as a guide to the development of their individual construction BMP ordinances. In this way, EPA Phase II jurisdictions would retain the flexibility in developing their BMPs to meet their individual needs. However, the NWA Stormwater Focus team strongly recommends that the information in this document be followed as closely as possible in order to promote regional consistency. This will be an important step in helping to standardize the BMPs used by design engineers & architects, developers, contractors, and erosion control professionals in Northwest Arkansas.

With the promulgation of the NPDES Storm Water Phase II regulations by the U.S. EPA, small MS4s in urbanized areas must implement a Storm Water Management Program (SWMP), which as a minimum must include the following six control measures:

1. Public education and outreach
2. Public participation and involvement
3. Illicit discharge detection and elimination
4. Construction site runoff control
5. Post-construction runoff control
6. Pollution prevention and good housekeeping

Glossary

- ADEQ:** Arkansas Department of Environmental Quality
- AHTD:** Arkansas Highway and Transportation Department
- AKART:** All Known, Available, and Reasonable means have been Taken
- ASTM:** American Society for Testing and Materials
- ATB:** Asphalt-Treated Base
- BFM:** Bonded-Fiber Matrix
- BMP:** Best Management Practice; schedule of activities, practices, or procedures to prevent or reduce the pollution of water; includes treatments, structural and non-structural controls, drainage, storage, cleaning and disposal of raw or created gases, liquids, and solids
- BOD:** Biological Oxygen Demand
- CCSO:** Certified Contractor's Site Official
- CESSCP:** Contractor's Erosion and Sediment Control Plan
- CESSI:** Certified Erosion, Sediment, and Stormwater Inspector
- CFR:** Code of Federal Regulations
- CMS4S:** Certified MS4 Specialist
- CPESC:** Certified Professional in Erosion and Sediment Control
- CPSWQ:** Certified Professional in Storm Water Quality
- CWA:** Clean Water Act (federal); also referred to as the Federal Water Pollution Control Act; Federal Water Pollution Control Act Amendments of 1972; Publication L. 92-500, as amended Publication L. 95-217; Publication L. 95-576, Publication L. 97-117, 33 U.S.C. 1251, et. seq.
- DOT:** Department Of Transportation (either federal or state)
- Dry Season:** the part of a 12-month yearly cycle that is least likely to receive any quantity of stormwater; in NW Arkansas this time period is generally between May 1 and September 30.
- ELG:** Effluent Limitation Guidelines
- EPA:** United States Environmental Protection Agency
- ESA:** Endangered Species Act
- E&SC or ESC:** Erosion and Sediment Control
- FEMA:** Federal Emergency Management Agency
- Hog fuel:** sawdust, tree bark, wood chips or shavings, mulch, other wood and yard-waste-type materials from sawmills and other raw wood processors that is used for fuel, landfill cover, animal feed, and surfacing materials; should not contain rocks, dirt, metal, plastic, or slag and should not have been subjected to saltwater.
- HUC:** Hydrologic Unit Code; a unique series of 2 to 8 numbers used to identify a watershed; the first 2 digits represent the division of the US into 21 regions, the second 2 digits represent sub-regions, the next 2 digits represent accounting units, and last pair of digits are cataloging units; efforts are underway to add 2 additional sets of numbers to further identify sub-watershed areas and reaches
- IDDE:** Illicit Discharge Detection and Elimination; a system of processes, procedures, plans, or programs instituted to detect, locate, and prevent illicit connections and discharges
- IECA:** International Erosion Control Association; multi-national association devoted to helping people solve the problems caused by erosion and sediment
- Illicit connection:** any conveyance (usually man-made) transporting a prohibited discharge to a NPDES-permitted MS4 entity or its stormwater system
- Illicit discharge:** any prohibited discharge to a stormwater system; any discharge to a stormwater system that is not exclusively stormwater (i.e. rain water, snow, ice, hail)
- MBFM:** Mechanically Bonded Fiber Matrix
- MCM:** Minimum Control Measure; one of 6 elements required of a MS4's management program or plan; 6 elements working together with the expectation to produce results in the significant reduction of

pollutants discharged to a water body

MEP: Maximum Extent Practicable

MS4: Municipal Separate Stormwater Sewer System; can be a single or mixture of municipalities, private or public universities, hospitals, or other government-run operations (such as military bases or prisons) within an UA the are required to meet requirements of the NPDES, CWA, EPA, ESA, USFWS, and other federal regulatory agencies or legislation

NOEC: No Observed Effects Concentration

NOI: Notice of Intent; the mechanism to “register” for coverage under a permit issued by a higher regulating authority

NOT: Notice of Termination; the mechanism to “terminate” coverage of a permit issued by a higher regulating authority once stabilization requirements have been met

NPDES: National Pollutant Discharge Elimination System

NPDES permit: tailored permit containing limits on discharges; monitoring and reporting requirements; and other provisions to ensure water quality and address other health or safety concerns

NTU: Nephelometric Turbidity Unit; unit measuring the lack of clarity of water; Water containing 1 milligram of finely divided silica per liter has a turbidity of 1 NTU

NWA: NorthWest Arkansas

Operator: the party or parties that meet one or more of the following descriptions:

- Has operational control over construction plans and specifications including the ability to make modifications to them;
- Has daily operational control over activities at a site to ensure that compliance with a SWP3, permit, or other regulatory actions

Owner: the party or parties that own or otherwise have financial control over activities on a site

PAM: Poly-acryl Amide; a polymer formed from acryl amide subunits; highly water-absorbent; used to flocculate or coagulate solids in a liquid; used as a soil conditioner to protect the water quality

Phase I CWA: federal regulations enacted in 1990 mandating stormwater management for locations meeting certain requirements

Phase II CWA: federal regulations enacted in 2003 mandating stormwater management for (smaller urbanized) locations meeting certain requirements

pH: measurement of how acidic or basic a material is

Qualified Person: an individual who has received education, training and/or certification at a local, regional, state, or national stormwater event that is recognized by either a local, state, or national organization; examples include Hot Springs (AR) QLP, CPESC, CESSWI, and CPSWQ certifications

Recharge Area: area or location where stormwater drains into the ground that later re-surfaces as a spring, flows from a well, or other groundwater source

Receiving Water: a water body serving as the “collector” of one or more watersheds

RUSLE: Revised Universal Soil Loss Equation

Scour: to scrub or rub hard on the surface of something especially by swift-flowing water

Storm water or Stormwater: defined by 40 CFR §122.26(b)(13); includes runoff of water (in all forms) as it falls from the sky or is released from a certified drinking water supply onto the surface of the ground, or the drainage of the runoff

Sump depth: the depth of a receptacle or reservoir into which stormwater is drained in order to be pumped out after being treated for sediment and other possible pollutants collected

SWMM: Storm Water Management Manual

SWMP: Storm Water Management Program or Storm Water Master Plan; a comprehensive written document to define and manage how storm water and its runoff will be dealt with by a MS4, including how each of 6 MCMs will be used to address the quality (and possibly quantity) of runoff before leaving its jurisdiction

SWPPP or SWP3: Storm Water Pollution Prevention Plan; a living document that indicates how erosion and sediment will be controlled through the use of various BMPs

TESC: Temporary Erosion and Sediment Control

TMDL: Total Maximum Daily Load

TSS: Total Suspended Solids

UA: Urbanized Area; as defined by the U.S. Census Bureau, a contiguously-connected land area contains portions or all of one or more municipalities (incorporated or not) with a total population over 50,000 people and an overall density of at least 1,000 people per square mile

USDA: United States Department of Agriculture

USFWS: U.S. Fish & Wildlife Service

Ultimate Receiving Water: a surface water body that receives discharges from multiple watersheds, often a river or substantial-size lake with an 8-digit (or fewer) HUC

Watershed: the ground surface area that drains all stormwater runoff to a single discharge location

Wet Season or **Rainy Season:** the part of a yearly weather cycle that is most likely for regular, large quantities in significant amounts of stormwater fall; in tropical climates are often referred to as the monsoon season; in NW Arkansas this time period is generally between October 1 and April 30

Units of measure:

cfs: cubic feet per second

fps: feet per second

gpm: gallons per minute

pcf: pounds per cubic foot

psf: pounds per square foot

psi: pounds per square inch

sf: square foot or square feet

µm: micrometer; the fraction of one millionth of a meter

Locations within the 2000 NWA UA (Code 297):

- | | | |
|------------------|----------------|--|
| • Benton County | • Fayetteville | • Springdale |
| • Bentonville | • Greenland | • University of Arkansas - Fayetteville campus |
| • Bethel Heights | • Johnson | • Washington County |
| • Elkins | • Little Flock | |
| • Elm Springs | • Lowell | |
| • Farmington | • Rogers | |

Locations added to the northwest Arkansas Urbanized Area due to the 2010 Census:

- | | | |
|----------------|-------------|-----------------|
| • Bella Vista | • Centerton | • Prairie Grove |
| • Cave Springs | • Pea Ridge | • Tontitown |

Introduction

This Stormwater Best Management Practice (BMP) Manual is entirely devoted to stormwater effects and controls associated with construction activities. It addresses the planning, design, and implementation of stormwater management activities prior to and during the construction phase of projects.

The objective of this manual is to provide guidance for avoiding adverse stormwater impacts from construction activities on downstream resources and on-site stormwater facilities. Minimizing stormwater flows, prevention of soil erosion, capture of water-borne sediment that has been unavoidably released from exposed soils, and protection of water quality from on-site pollutant sources are all readily achievable when the proper BMPs are planned, installed, and properly maintained.

Initial discussions between the project proponents and their designer, contractors, and compliance inspectors can identify approaches to accomplishing a high quality, cost-effective project without compromising environmental protection. Often new ways are found to stage, time, and phase parts of a project to economize a contractor's schedule and use of construction materials. This collaborative planning process can produce methods to minimize or eliminate vulnerability and unnecessary risk associated with some traditional construction practices and techniques.

The construction phase of a project is usually considered a temporary condition, which will be supplanted by the permanent improvements and facilities for the completed project. However, construction work may take place over an extended period of time, including several seasons of multiple years. All management practices and control facilities used in the course of construction should be of sufficient size, strength, and durability to readily outlast the longest possible construction schedule and the worst anticipated rainfall conditions.

Linear projects, such as roadway construction and utility installations, are special cases of construction activities and present their own, unique set of stormwater protection challenges. Many of the BMPs can be adapted and modified to provide the controls needed to adequately address these projects. It may be advantageous to segment long, linear projects into a series of separate units that can apply all necessary controls pertinent to that particular unit in a timely manner.

The goal of a Stormwater Pollution Prevention Plan (SWPPP) is to avoid immediate and long-term environmental loss and degradation typically caused by poorly managed construction sites. Prompt design and implementation of a Construction SWPPP can provide a number of benefits. These include minimizing construction delays, reducing resources spent on repairing erosion, improving the relationship between the contractor and the permitting authority, and limiting adverse effects on the environment. Many of the BMPs contained in this volume can be adapted and modified to provide the erosion and sediment controls needed for other activities.

The Construction Stormwater Pollution Prevention Plan requires that new development and redevelopment projects address stormwater pollution prevention during construction. The SWPPP must describe construction practices, stabilization techniques, and structural BMPs that are to be implemented to prevent erosion and minimize sediment transport. Erosion prevention, sediment control, and pollution control BMP guidance and design criteria are provided later in this manual. Projects that clear more than 1,000 square feet must prepare a City Grading Permit and a Stormwater Pollution Prevention Plan (SWPPP) that is reviewed by the City. The SWPPP must contain sufficient information to satisfy the City that the problems of pollution have been adequately addressed for the proposed project. Projects that add or replace less than ½ acre of impervious surface or clearing projects of less than 1,000 square feet are not required to prepare a City Grading Permit and a SWPPP. However, projects of less than 1,000 square feet that will discharge stormwater from the site into surface water(s), or into storm drainage systems that discharge to a surface water, must address pollution prevention.

Final stabilization must be completed for stormwater discharges that originate from the site after construction has been completed. Final stabilization means the completion of all soil disturbing activities at the site and the establishment of a permanent vegetative cover, or equivalent permanent stabilization measures such as native stone, gabions, or geo-textiles which will prevent erosion and pollution from leaving the site.

Stormwater discharges associated with construction activity are subject to applicable federal and state water quality standards. Neither the federal or state Stormwater General Construction Permit authorizes the violation of those standards. ADEQ expects that the selection and implementation of appropriate BMPs outlined in this or equivalent manuals will result in compliance with water quality standards. Proper implementation and maintenance of appropriate BMPs is critical to adequately control any adverse water quality impacts from construction activity.

Stormwater discharges from construction sites must not cause or contribute to violations of Arkansas's surface water quality standards, sediment management standards, ground water quality standards, and human health.

Standards and Specifications for Best Management Practices

Best Management Practices (BMPs) are defined as schedules of activities, prohibitions of practices, maintenance procedures, and structural and/or managerial practices, that when used singly or in combination, prevent or reduce the release of pollutants to waters of the state. This manual contains standards and specifications for various temporary and permanent BMPs to be used prior to, during, and/or after the design and construction phases of a project. Permanent BMPs included must meet their own Maintenance Standards to remain effective during their post-construction life.

Chapter 1 contains the standards and specifications for Preventative BMPs.

Chapter 2 contains the standards and specifications for Access and Source Control BMPs.

Chapter 3 contains the standards and specifications for Conveyance BMPs.

Chapter 4 contains the standards and specifications for Treatment BMPs.

The standards for each individual BMP are divided into four sections:

1. Purpose
2. Conditions of Use
3. Design and Installation Specifications
4. Maintenance Standards

“Conditions of Use” refers to site conditions. As site conditions change, BMPs must be maintained or changed to remain in compliance.

“Design and Installation Specifications” may be determined by a designer, manufacturer, installer, and/or regulating entities (such as a local or state agency). Trademarked, brand name, and/or patented BMPs shall be ruled by their manufacturing and installation disclaimers. This manual will try to avoid referencing such devices but may generally describe a “class” of devices that are similar in installation, operation, and purpose and that can be found through various suppliers and dealers. The terms and guidelines for the BMP devices listed are the preferred techniques of Northwest Arkansas municipal stormwater inspectors (who helped create this manual) and supervisors, and are controlled by the collective (regional) stormwater ordinance(s) of those municipalities listed before the Introduction on pages viii and ix.

“Maintenance Standards” must be met to keep each BMP effective. If the BMP and/or its devices are not regularly inspected and maintained, it/they will need to be replaced during the project’s construction phase to keep the overall site in compliance.

Chapter 1: Preventative BMPs

BMP 101: Preserving Natural Vegetation

Purpose

The purpose of preserving natural vegetation is to reduce erosion wherever practicable. Limiting site disturbance is the single most effective method for reducing erosion. For example, conifers can hold up to about 50% of all rain that falls during a storm. Up to 20%-30% of this rain may never reach the ground but is taken up by the tree or evaporates. Another benefit is that the rain held in the tree can be released slowly to the ground after the storm.

Conditions of Use

- Natural vegetation should be preserved on steep slopes, near perennial and intermittent watercourses or swales, and on building sites in wooded areas.
- As required by local governments.

Design and Installation Specifications

Natural vegetation can be preserved in natural clumps or as individual trees, shrubs and vines. The preservation of individual plants is more difficult because heavy equipment is generally used to remove unwanted vegetation. The points to remember when attempting to save individual plants are:

- Is the plant worth saving? Consider the location, species, size, age, vigor, and the work involved. Local governments may also have ordinances to save natural vegetation and trees.
- Fence or clearly mark areas around trees that are to be saved. It is preferable to keep ground disturbance away from the trees at least as far out as the drip-line. Plants need protection from three kinds of injuries:
 - **Construction Equipment** - This injury can be above or below the ground level. Damage results from scarring, cutting of roots, and compaction of the soil. Placing a fenced buffer zone around plants to be saved prior to construction can prevent construction equipment injuries.
 - **Grade Changes** - Changing the natural ground level will alter grades, which affects the plant's ability to obtain the necessary air, water, and minerals. Minor fills usually do not cause problems although sensitivity between species does vary and should be checked. Trees can tolerate fill of 6" or less. For shrubs and other plants, the fill should be less.

When there are major changes in grade, it may become necessary to supply air to the roots of plants. This can be done by placing a layer of gravel and a tile system over the roots before the fill is made. A tile system protects a tree from a raised grade. The tile system should be laid out on the original grade leading from a dry well around the tree trunk. The system should then be covered with small stones to allow air to circulate over the root area.

Lowering the natural ground level can seriously damage trees and shrubs. The highest percentage of the plant roots are in the upper 12" of the soil and cuts of only 2" to 3" can cause serious injury. To protect the roots it may be necessary to terrace the immediate area around the plants to be saved. If roots are exposed, construction of retaining walls may be needed to keep the soil in place. Plants can also be preserved by leaving them on an undisturbed, gently sloping mound. To increase the chances for survival, it is best to limit grade changes and other soil disturbances to areas outside the drip-line of the plant.

- **Excavations** - Protect trees and other plants when excavating for drain fields, power, water, and sewer lines. Where possible, the trenches should be routed around trees and large shrubs. When this is not possible, it is best to tunnel under them. This can be done with hand tools or with power augers. If it is not possible to route the trench around plants to be saved, then the following should be observed.
 - Cut as few roots as possible. When you have to cut, cut clean. Paint cut root ends with a wood dressing like asphalt base paint. Backfill the trench as soon as possible and tunnel beneath root

systems as close to the center of the main trunk to preserve most of the important feeder roots. Some problems that can be encountered with a few specific trees are:

- Maple, Dogwood, Western red cedar, and Douglas fir do not readily adjust to changes in environment and special care should be taken to protect these trees.
- Cottonwoods, maples, and willows have water-seeking roots. These can cause trouble in sewer lines and infiltration fields. On the other hand, they thrive in high moisture conditions that other trees would not. Disease can become established through damaged limbs, trunks, roots, and freshly cut stumps. Diseased and weakened trees are also susceptible to insect attack.

Maintenance Standards

- Inspect flagged and/or fenced areas regularly to make sure flagging or fencing has not been removed or damaged. If the flagging or fencing has been damaged or visibility reduced, it shall be repaired or replaced immediately and visibility restored.
- If tree roots have been exposed or injured, “prune” cleanly with an appropriate pruning saw or loppers directly above the damaged roots and recover with native soils. Treatment of sap-flowing trees (fir, hemlock, pine, soft maples) is not advised as sap forms a natural healing barrier.

BMP 102: Buffer Zones

Purpose

An undisturbed area or strip of natural vegetation or an established suitable planting that will provide a living filter to reduce soil erosion and runoff velocities.

Conditions of Use

Natural buffer zones are used along streams, wetlands and other bodies of water that need protection from erosion and sedimentation. Vegetative buffer zones can be used to protect natural swales and can be incorporated into the natural landscaping of an area.

Critical-areas buffer zones should not be used as sediment treatment areas. These areas shall remain completely undisturbed. The local permitting authority may expand the buffer widths temporarily to allow the use of the expanded area for removal of sediment.

Design and Installation Specifications

- Preserving natural vegetation or plantings in clumps, blocks, or strips is generally the easiest and most successful method.
- Leave all unstable steep slopes in natural vegetation.
- Mark clearing limits and keep all equipment and construction debris out of the natural areas. Steel construction fencing is the most effective method in protecting sensitive areas and buffers. Alternatively, wire-backed silt fence on steel posts is marginally effective. Flagging alone is typically not effective.
- Keep all excavations outside the drip-line of trees and shrubs.
- Do not push debris or extra soil into the buffer zone area because it will cause damage from burying and smothering.
- Vegetative buffer zones for streams, lakes or other waterways shall be established by the local permitting authority or other state or federal permits or approvals.

Maintenance Standards

Inspect the area frequently to make sure flagging remains in place and the area remains undisturbed.

BMP 103: Wetland Preservation, Creations, and Re-creation

Purpose

A recognized or historical location of ponding water surrounded by an undisturbed area and strip of natural vegetation. Ponding occurs because it matches the elevation of the ground water table. May or may not be attached to a recognized drainage area or passageway of storm water runoff. Existing areas to be preserved will have natural vegetation or established suitable plantings that provide a living filter. Creation of “new” or “reclaimed” wetlands should contain vegetation similar to the nearest wetland that protect against soil erosion, reduce runoff velocities, and other similar benefits while withstanding long periods of saturated or super-saturated soil conditions.

Conditions of Use

Natural buffers used to stabilize erosion and sedimentation while being incorporated into the natural landscaping of an area. The permitting authorities may require, expand, or extend in exchange for other requested improvements or developments.

Design and Installation Specifications

- Preserving natural vegetation is generally the easiest and most successful method.
- Transplanting in clumps, blocks, or strips from existing sites that match as closely as possible in the same watershed provides the best materials when reclaiming or establishing new wetland areas.
- Mark clearing limits and keep all equipment and construction debris out of the natural areas. Steel construction fencing is the most effective method in protecting sensitive areas and buffers. Alternatively, wire-backed silt fence on steel posts is marginally effective. Flagging alone is typically not effective.
- Keep all excavations outside the drip-line of trees and shrubs.
- Do not push debris or extra soil into the buffer zone area because it will cause damage from burying and smothering.
- Vegetative buffer zones for streams, lakes or other waterways shall be established by the local permitting authority or other state or federal permits or approvals.

Maintenance Standards

- Inspect the area frequently to make sure fencing and flagging remains in place and the area remains undisturbed.
- Reclaimed or new areas will need inspection every 4 weeks for at least one year after planting to check for damaged or dead vegetation; whether too little, sufficient, or too much groundwater is available for the vegetation present; invasive species overtaking area; and whether area is correctly “operating” as wanted.

BMP 104: Floodways and Floodplains

Purpose

A recognized or historical location of running water; a recognized drainage area or passageway of storm water runoff. Most locations have been estimated or mapped by the Federal Emergency Management Agency (FEMA) as a part of their National Flood Insurance Program’s (NFIP) Flood Insurance Rate Map (FIRM) system. These maps help the government determine the likelihood that a particular area may or may not be flooded; the approximate elevation that the water may reach in a particular flooding event; and whether additional insurance should be requested by insurance, mortgage, and other title-related companies on particular pieces of property near these locations.

Conditions of Use

If one of these potentials falls within a development area, the limits of the mapped or unstudied floodway or floodplain should be determined prior design as many municipalities have minimum elevation requirements for structures within their limits.

The existence of one or both of these items can also affect whether development can occur; the size of the disturbance area; whether cut materials can be removed or fill materials can be placed on the site; the type of fill materials that can be added; the number and types of construction and post-construction BMPs required; whether a Corps of Engineers permit is required; whether there are additional restrictions on the site that are not obvious from a visual inspection of the site (such as unmarked or mitigated wetlands); and numerous other items.

Design and Installation Specifications

If an unstudied potential floodway or floodplain is found to exist within a site under consideration for development is located, additional design criteria will be considered and may require that the local municipality's floodplain administrator is contacted for guidance to meet all federal, state, and local requirements for the development to progress. This may include official studying of the stretch of the drainage way that the site is located within. An official study usually covers over a mile stretch of a "main" channel and several "major" tributaries.

If the drainage channel (stream, creek, ditch, etc.) or water body is found to have limitations on it (TMDL, ELG, etc.), additional restrictions may be placed on the site that may require additional numbers and types of construction and post-construction BMPs required.

Maintenance Standards

Stable floodway areas should be reviewed after every major storm (as defined locally) to verify the channel has retained its stability. Repairs and maintenance should be limited to banks and vegetation to maintain water flow; removal of blockages (potential or perceived); erosion and scour prevention; and slope stability.

Floodplains should be reviewed annually (preferably during winter months) to check for channel, bank slope, and vegetation stability; erosion and scour development; newly placed or recently exposed at-grade or below-grade utility crossings; addition or removal of structures, certain types of fencing, excessive amounts of newly planted or removed large trees, landscaping, or other vegetative areas; the creation of rills and gullies; etc.

Floodway and floodplain areas should be maintained and cleared of excessive amounts of small brush and debris by brush-hogging or hand-clearing at least once a year. Larger debris should be reviewed on a case-by-case basis to determine if it is creating (or the result of) an erosion or scour problem, but if the area is stable then it should be left alone - as long as it does not become a potential (floating) blockage to downstream vehicular crossings (bridges, culverts, drain pipes, etc.).

BMP 105: Watershed vs. Site Drainage***Purpose***

When drainage for a development is considered, both the increased runoff from the development as well as the "built-out" improvements to the entire watershed should be considered.

In some cases, the development area may only be a very small fraction of the entire watershed. This means the site discharging flow may: contribute pollutants to the receiving flow that previously had either not been present or were below levels of significance to the flow; increase the quantity of water to create far-reaching up- and/or down-stream flooding or erosion conditions; significantly change the quality or other characteristics of the water flow; or have no effect at all.

In other cases, the development site may occur at the top of a watershed, so may affect several different

watersheds. If this occurs and water runoff is “re-located” from one watershed to another, there can be a more visual affect on both watersheds (drying of one, increased flow in another).

Soil conditions should also be considered when looking at the discharging flow. If the site is in a karst region, the pre-development runoff may be discharging to what appears to be a surface water body, but disturbance of the soil’s surface or subgrade conditions may expose a more pervious medium for the runoff to pass through when discharging. This can lead to “disappearing” stream conditions that may greatly affect both up- and down-stream neighbors, particularly in more rural areas that depend on the surface water bodies to irrigate crops or grazing animals.

Conditions of Use

Northwest Arkansas is in a highly karst region that has known environmentally sensitive habitats, so subgrade conditions should be carefully reviewed and be suspected as highly varied throughout an entire development of any significant size (over 1.00 acre).

Because Northwest Arkansas also has large areas of very “flat” terrain compared to other very larger areas of extreme slopes, the location of each development site can not always be approached with a “one size fits all” attitude. Not reviewing the difficulties of pre-developed and adjoining terrains, runoff drainage ways, and how the during construction and the post-developed site will change both of these can have significant impacts on the life-expectancy and maintenance schedule of any BMP attempted to be used.

Design and Installation Specifications

BMPs should be reviewed to verify that those selected for use and shown in the SWP3 living document are designed for use in the terrain conditions of the site. Depending on the BMP selected, it may work on that type of terrain but used more frequently than is practical during construction. Larger developments may have their final “permanent” BMPs installed during an early phase of the development, but if not maintained or other intermediate BMPs installed, it could fail prior to the end of the development phase. This means that something that was supposedly complete, may have to be removed, disposed of, and replaced before the project can be accepted by either the owner, developer, or municipality where it is located.

Maintenance Standards

All discharge inlets and outfalls of all developments should be reviewed at least once every other year to check for stability; erosion, rills, gullies, and scour development; blockages by vegetation or man-made objects; cleanliness; connectivity to any piping; etc. If repairs, cleaning, re-grading, or replacement are needed they should be scheduled to occur as quickly as possible but preferably during the dry season to avoid polluting the waters connected to the inlet/outlet.

BMP 110: Dust Prevention and Control

Purpose

Dust control prevents wind transport of dust from disturbed soil surfaces onto roadways, drainage ways, and surface waters.

Conditions of Use

Dust prevention and control is needed in areas (including roadways) subject to surface and air movement of dust on-site and off-site impacts roadways, drainage ways, or surface waters.

Design and Installation Specifications

- Vegetate or mulch areas that will not receive vehicle traffic. In areas where planting, mulching, or paving is impractical, apply gravel or landscaping rock.

- Limit dust generation by clearing only those areas where immediate activity will take place, leaving the remaining area(s) in the original condition, if stable. Maintain the original ground cover as long as practical.
- Leave or create natural windbreaks or construct artificial windscreens. Artificial ones can be designed as enclosures for small dust sources. Some screens also have “blinding” or opaque qualities to help “obscure” the view of the site while reducing the amount of wind-carried particles transported off the site.
- Sprinkle and spray unpaved areas with water or other approved liquids until surface is wet. Repeat as needed. To prevent carryout of mud and other solids onto street, refer to Stabilized Construction Exit (BMP 210).
- Irrigation water can be used for dust control. Irrigation systems should be installed as a first step on sites where dust control is a concern.
- Spray exposed soil areas with a dust palliative. Follow the manufacturer’s instructions and cautions regarding handling and application. Used oil is prohibited from use as a dust suppressant. Local governments may approve other dust palliatives such as calcium chloride or PAM.
- PAM (BMP 226) added to water and applied from a water truck can increase the infiltration of water into the soil and reduced evaporation. In addition, small soil particles are bonded together and are not as easily transported by wind. Adding PAM may actually reduce the quantity of water needed for dust control. Since the wholesale cost is relatively inexpensive, this is an extremely cost-effective dust control method.

Examples of techniques that can be used:

- Lowering speed limits. High vehicle speeds increase the amount of dust stirred up from unpaved roads and lots.
- Upgrade the road surface strength by improving particle size, shape, and mineral types that make up the surface and base materials.
- Add surface gravel to reduce the source of dust emission. Limit the amount of fine particles (smaller than 0.075 mm) in the surface improvement to between 10% and 20%.
- Use geo-textile fabrics to increase the strength of new roads or roads under reconstruction.
- Encourage the use of alternate, stabilized routes that could be graveled, paved, matted, or padded.
- Restrict use by tracked vehicles and heavy trucks to prevent damage to road surface and base.
- Apply chemical dust suppressants using the admix method, blending the product with the top few inches of surface material. Suppressants may also be applied as surface treatments.
- Pave unpaved permanent roads and other trafficked areas.
- Use vacuum street sweepers.
- Remove mud and other dirt promptly so it does not dry and then turn into dust.
- Limit dust-causing work on windy days.
- Contact ADEQ for guidance and training on other dust control measures. Compliance with the local municipality constitutes compliance with this BMP.

Maintenance Standards

Re-spray disturbed areas as necessary to keep dust to a minimum.

If natural windbreaks are created or left in place, they should be inspected at least once a month to review for health and vigor. Dead trees and plants that were to exist at the end of the construction project should be replaced with similar sized and types of vegetation that meet the jurisdictional and project standards.

If artificial windscreens are erected they should be inspected at least once a week on both sides for evidence of any “escaping” dust. Damaged sections should be repaired and/or replaced in a timely manner.

If a screen shows evidence of considerable dust collection, it may need to be cleaned, repaired, and/or replaced. It may need to be supported during the process to prevent the collected particles from escaping.

If water is used for cleaning, it needs to be treated by a water runoff BMP.

Depending on the amount of collection on the screen, additional measures may also be required to prevent the fine particles from becoming airborne and reaching the screen. For example, the erection of an artificial windscreen between a row of natural vegetation (to remain after construction) and an internal

access route could reduce or prevent the accumulation of particles on the existing vegetation.

BMP 120: Kits and Containment Materials

Purpose

Quantities of erosion prevention and sediment control materials can be kept on the project site at all times to be used for emergency situations such as unexpected heavy summer rains. Having these materials on-site reduces the time needed to implement BMPs when inspections indicate that existing BMPs are not meeting the Construction SWPPP requirements. In addition, contractors can save money by buying some materials in bulk and storing them at their office or yard.

1. A first aid kit should be kept on-site for emergencies.
2. A spill kit should be kept on-site to prevent, treat, and/or clean-up leaks and spills of materials and/or fluids from equipment used on-site.

Conditions of Use

Construction projects of any size or type can benefit from having materials on hand. A small commercial development project could have a roll of plastic and some gravel available for immediate protection of bare soil and temporary berm construction. A large earthwork project, such as highway construction, might have several tons of straw, several rolls of plastic, flexible pipe, sandbags, geo-textile fabric and steel T-posts.

Materials are stockpiled and readily available before any site clearing, grubbing, or earthwork begins. A large contractor or developer could keep a stockpile of materials that are available to be used on several projects.

If storage space at the project site is at a premium, the contractor could maintain the materials at their office or yard. However, the office or yard must be less than an hour from the project site.

Design and Installation Specifications

A first aid kit should include – at a minimum - sanitary hand/face wipes, tape, roll gauze, eye wash, bandages, pressure bandages, local emergency services contact information, and CPR and first aid instructions. Company contacts for accident-reporting and insurance contacts should also be listed.

Spill and leak prevention, treatment, and clean-up items include oil pans and/or buckets; kitty-litter, sand, gravel, or other absorbent materials that can be swept; absorbent pads and/or booms for containing liquids on dry surfaces or can be placed across flowing-waters; tarps; stakes and/or posts for holding or supporting fabric, pads, booms, or tarps in place; brooms and dustpans; mop and bucket; etc. The spill kit should also include, at a minimum:

- Water Resistant Nylon Bag (1 each)
- Oil Absorbent Socks 3"x 4' (3 each)
- Oil Absorbent Socks 3"x 10' (2 each)
- Oil Absorbent Pads 17"x19" (12 each)
- Splash Resistant Goggles (1 pair)
- Nitrile Gloves (3 pairs each of multiple sizes)
- Disposable Bags with Ties (10 each)
- Instructions for each item included in kit
- Emergency contact information for local emergency services
- Emergency contact information for company contacts (i.e. 24-hour hotlines)
- Material Safety Data Sheets (MSDS) for all materials stored on-site.

Depending on project type, size, complexity, and length, erosion and sediment control materials and quantities may vary. A good minimum list of items that will cover numerous situations includes:

Table 1: On-Hand Containment Materials

Material	Measure	Quantity
Clear plastic, 6 mm	100-foot roll	1 to 2 rolls
Drain pipe, 6" or 8" diameter	25-foot section	4 to 6 sections
Sand- or gravel-filled bags	each	25 to 50 each
Straw or other mulch	approx 50 lbs	10 to 20 bales
Gravel	tons or cubic yards	2 to 4 tons
Geo-textile fabric	100-foot roll	1 to 2 rolls
Catch basin protection (inlet)	each	2 to 4 each
Steel T-posts	each	12 to 24 each

Maintenance Standards

Each item in the first aid and spill kits should have an expiration date on it. All items should be replaced as they are used, or every twelve (12) months.

All materials with the exception of the steel T-posts, and gravel should be kept covered and out of both sun and rain. Re-stock materials used as needed. Fabrics and bags should be replaced at the beginning of each new project.

BMP 121: Material Delivery***Purpose***

Prevent, reduce, or eliminate the discharge of pollutants from material delivery by storing materials in designated areas.

Conditions of Use

These procedures are suitable for use at all construction sites with delivery of materials.

Design and Installation Specifications

The following steps should be taken to minimize risk:

- Temporary storage area should be located away from vehicular traffic, near the construction entrance(s), and away from waterways or storm drains.
- Material Safety Data Sheets (MSDS) should be supplied for all materials stored. Chemicals should be kept in their original labeled containers.
- Hazardous material storage on-site should be minimized.
- During the wet weather season (Oct 1 – April 30), consider storing materials in a covered area.
- Do not store chemicals, drums, or bagged materials directly on the ground. Place these items on a pallet and, when possible, in secondary containment.
- If drums must be kept uncovered, store them at a slight angle to reduce ponding of rainwater on the lids to reduce corrosion. Domed plastic covers are inexpensive and snap to the top of drums, preventing water from collecting.

Material Delivery Areas:

- Liquids, petroleum products, and substances listed in 40 CFR Parts 4-53 110, 117, or 302 shall be delivered in approved containers and drums; shall not be overfilled; and shall be stored in temporary secondary containment facilities with the volume capacity of 110% of the largest container within its boundary, or 110% of the sum of all containers within the containment field, whichever is greater.
- Sufficient access and separation should be provided to allow for spill cleanup and emergency response.
- During the wet weather season (Oct 1 – April 30), each delivery and storage facility shall be covered during non-working days, prior to and during rain events.

Maintenance Standards

All delivery areas should be reviewed daily for cleanliness; organization; sufficient separation between stored containers; and space for delivery vehicles to park, maneuver, and access all storage areas.

BMP 122: Material Storage***Purpose***

Prevent, reduce, or eliminate the discharge of pollutants from material storage to the storm water system or watercourses by minimizing the storage of hazardous materials onsite and by storing materials in a designated area.

Conditions of Use

These procedures are suitable for use at all construction sites with storage of any material, but in particular for the following:

- Petroleum products such as fuel, oil and grease
- Soil stabilizers and binders (e.g. PAM)
- Fertilizers, pesticides and herbicides
- Detergents
- Asphalt and concrete compounds
- Hazardous chemicals such as acids, lime, adhesives, paints, solvents and curing compounds
- Any other material that may be detrimental if released to the environment

Design and Installation Specifications

The following steps should be taken to minimize risk:

- Temporary storage area should be located away from vehicular traffic, near the construction entrance(s), and away from waterways or storm drains.
- Material Safety Data Sheets (MSDS) should be supplied for all materials stored. Chemicals should be kept in their original labeled containers.
- Hazardous material storage on-site should be minimized.
- Hazardous materials should be handled as infrequently as possible.
- During the wet weather season (Oct 1 – April 30), consider storing materials in a covered area.
- Materials should be stored in secondary containments, such as earthen dike, horse trough, or even a children's wading pool for non-reactive materials such as detergents, oil, grease, and paints. Small amounts of material may be secondarily contained in "bus boy" trays or concrete mixing trays.
- Do not store chemicals, drums, or bagged materials directly on the ground. Place these items on a pallet and, when possible, in secondary containment.
- If drums must be kept uncovered, store them at a slight angle to reduce ponding of rainwater on the lids to reduce corrosion. Domed plastic covers are inexpensive and snap to the top of drums, preventing water from collecting.

Material Storage Areas:

- Containers and drums shall be stored in temporary secondary containment facilities.
- In the event of spills or leaks, accumulated rainwater and spills shall be collected and placed into drums. These liquids shall be handled as hazardous waste unless testing determines them to be non-hazardous.
- Sufficient access and separation should be provided between stored containers to allow for spill cleanup and emergency response access.
- During the wet weather season (Oct 1 – April 30), each containment facility shall be covered during non-working days, prior to and during rain events.

- Keep material storage areas clean, organized and equipped with an ample supply of appropriate spill clean-up material (spill kit).

Maintenance Standards

All storage areas should be reviewed daily for spills and/or leaks in containers; general cleanliness; organization; sufficient separation between stored containers; and space for delivery vehicles to park, maneuver, and access all storage areas.

Secondary containment areas should be checked weekly; before and after each storm event; and after every delivery for spills and/or leaks that need to be removed, cleaned, or treated and disposed of.

BMP 123: Material Containment

Purpose

Prevent, reduce, or eliminate the discharge of pollutants from material storage to the storm water system or watercourses by installing secondary containment.

Conditions of Use

These procedures are suitable for use at all construction sites with delivery and storage of any material, but in particular for the following:

- Petroleum products such as fuel, oil and grease
- Soil stabilizers and binders (e.g. PAM)
- Fertilizers, pesticides and herbicides
- Detergents
- Asphalt and concrete compounds
- Hazardous chemicals such as acids, lime, adhesives, paints, solvents and curing compounds
- Any other material that may be detrimental if released to the environment

Design and Installation Specifications

The following steps should be taken to minimize risk:

- Storage areas should be located away from vehicular traffic, near the construction entrance(s), and away from waterways or storm drains.
- Material Safety Data Sheets (MSDS) should be supplied for all materials stored. Chemicals should be kept in their original labeled containers.
- Hazardous material storage on-site should be minimized.
- Hazardous materials should be handled as infrequently as possible.
- During the wet weather season (Oct 1 – April 30), consider storing materials in a covered area.
- Materials should be stored in secondary containments, such as earthen dike, horse trough, or even a children's wading pool for non-reactive materials such as detergents, oil, grease, and paints. Small amounts of material may be secondarily contained in "bus boy" trays or concrete mixing trays.
- Do not store chemicals, drums, or bagged materials directly on the ground. Place these items on a pallet and, when possible, in secondary containment.
- If drums must be kept uncovered, store them at a slight angle to reduce ponding of rainwater on the lids to reduce corrosion. Domed plastic covers are inexpensive and snap to the top of drums, preventing water from collecting.

Secondary Containment Practices:

- Liquids, petroleum products, and substances listed in 40 CFR Parts 4-53 110, 117, or 302 shall be stored in approved containers and drums and shall not be overfilled. Containers and drums shall be stored in temporary secondary containment facilities.
- Temporary secondary containment facilities shall provide for a spill containment volume able to

contain precipitation from a 25 year, 24 hour storm event, plus 10% of the total enclosed container volume of all containers, or 110% of the capacity of the largest container within its boundary, whichever is greater.

- Secondary containment facilities shall be impervious to the materials stored therein for a minimum contact time of 72 hours.
- Secondary containment facilities shall be maintained free of accumulated rainwater and spills. In the event of spills or leaks, accumulated rainwater and spills shall be collected and placed into drums. These liquids shall be handled as hazardous waste unless testing determines them to be non-hazardous.
- Sufficient access and separation should be provided between stored containers to allow for spill cleanup and emergency response access.
- During the wet weather season (Oct 1 – April 30), each secondary containment facility shall be covered during non-working days, prior to and during rain events.
- Keep material storage areas clean, organized and equipped with an ample supply of appropriate spill clean-up material (spill kit). See BMP 120, Kits and Containment Materials for more details.

Maintenance Standards

All storage areas should be reviewed daily for spills and/or leaks in containers; general cleanliness; organization; sufficient separation between containers; and space for delivery vehicles to park, maneuver, and access all storage areas.

Secondary containment areas should be checked weekly; before and after each storm event; and after every delivery for spills and/or leaks that need to be removed, cleaned, or treated and disposed of.

BMP 124: Concrete Handling

Purpose

Concrete work can generate process water and slurry that contain fine particles and high pH, both of which can violate water quality standards in the receiving water. This BMP is intended to minimize and eliminate concrete process water and slurry from entering waters of the state.

Conditions of Use

Any time concrete is used these management practices shall be utilized. Concrete is often used on construction projects for, but are not limited to: curbs, sidewalks, roads, bridges, foundations, floors, walls, runways, driveways, parking lots and garages, patios, and manholes.

Design and Installation Specifications

Concrete truck chutes, pumps, and internals shall be washed out only into formed areas awaiting installation of concrete or asphalt.

- Unused concrete remaining in the truck and pump shall be returned to the originating batch plant for recycling.
- Hand tools including, but not limited to, screeds, shovels, rakes, floats, and trowels shall be washed off only into formed areas awaiting installation of concrete or asphalt.
- Equipment that cannot be easily moved, such as concrete pavers, shall only be washed in areas that do not directly drain to natural or constructed stormwater conveyances.
- Wash down from areas such as concrete aggregate driveways shall not drain directly to natural or constructed stormwater conveyances.
- When no formed areas are available, wash water and leftover product shall be contained in a lined container. The container can be single-use or re-usable as long as the concrete is contained.
- Contained concrete shall be disposed of in a manner that does not violate groundwater or surface

water quality standards.
See also BMP 132 Washouts for additional information.

Maintenance Standards

All containers shall be checked for holes daily during concrete pours and repaired the same day. Lined containers are more susceptible to puncturing; especially if cleaned out using “heavy” on-site equipment (anything larger than a shovel).

BMP 125: Saw-Cutting and Surfacing Pollution Prevention

Purpose

Saw-cutting and surfacing operations generate slurry and process water that contains fine particles and high pH, both of which can violate the water quality standards in the receiving water. This BMP is intended to minimize and eliminate process water and slurry from entering waters of the State.

Conditions of Use

Anytime saw-cutting or surfacing operations take place, these management practices shall be utilized. Saw-cutting and surfacing operations include, but are not limited to, the following: sawing, coring, grinding, roughening, hydro-demolition, bridge and road surfacing.

Design and Installation Specifications

- Slurry and cuttings shall be vacuumed during cutting and surfacing operations.
- Slurry and cuttings shall not remain on any permanent pavement between shifts.
- Slurry and cuttings shall not drain to any natural or constructed drainage conveyance.
- Collected slurry and cuttings shall be disposed of in a manner that does not violate groundwater or surface water quality standards.
- Process water that is generated during hydro-demolition, surface roughening, or similar operations shall not drain to any natural or constructed drainage conveyance and shall be disposed of in a manner that does not violate groundwater or surface water quality standards.
- Cleaning waste material and demolition debris shall be handled and disposed of in a manner that does not cause contamination of water.
- Surfaces on and adjacent to public travel ways shall not be opened to traffic (foot or vehicular) until the surface has been swept and/or vacuumed a second time to ensure that all slurry and cuttings have been collected.
- If the materials area is swept, all slurry and cuttings shall be picked up and gathered into a holding container until the end of each shift. The container then should be hauled to an appropriate disposal site at the necessary intervals.

Maintenance Standards

Continually monitor operations to determine whether slurry, cuttings, or process water could enter waters of the State. If inspections show that a violation of water quality standards could occur, stop operations and immediately implement preventive measures such as berms, barriers, secondary containment, and vacuum trucks.

BMP 130: Gross Solids and Solid Waste

Purpose

Every project should provide appropriate containers to accept solid and liquid items of trash, packing materials, construction debris, sweepings, spill clean-ups, etc.

Conditions of Use

Separate containers should be made available if hazardous materials are expected on-site. Hazardous material containers left on-site should be locked at all times. They should also be checked at least 3 times to look for leaks and spills in the 48-hour period immediately following each “addition” to the container.

Recyclables can also be collected separately from regular “trash” and potentially hazardous materials.

Design and Installation Specifications

Waste containers can be contractor-owner or supplied; supplied and maintained by a subcontractor; location could be part of an existing established municipal route.

All containers should be secured in such a way that the public can not access the container after hours for the disposal of non-site-related items. Unsecured containers that are easy to access tend to attract furniture and appliances.

Maintenance Standards

Most containers have a weight or volume limit. Unless part of a regularly maintained route, the container should be emptied before its capacity (by weight or volume) is reached.

Containers should be checked at least once per week for capacity and damage.

BMP 131: Sanitary Services

Purpose

Every project should provide access to sanitary services and drinking water for on-site employees.

Conditions of Use

Separate disposal containers should be made available if liquid hazardous materials are expected on-site.

Design and Installation Specifications

Provide and maintain ample sanitary facilities by the use of existing toilets, or a sufficient number of enclosed temporary toilets. If access is through the use of existing toilets, the public sewer service provider should be made aware of the approximate amount of use expected and length of project.

Safe and fresh drinking water shall be provided from single service containers, sanitary drinking stands, or fountains.

Facilities can be contractor-owner or supplied; supplied and maintained by a subcontractor; a may be part of an existing established municipal route.

All facilities should be secured in such a way that the public can not access the container after hours for the disposal of non-site-related items.

Maintenance Standards

Facilities should be serviced regularly, unless connected to a public sewer system. All facilities and services shall be furnished to strict accordance with federal, state and local laws and regulations.

BMP 132: Washouts

Purpose

Each site should provide a method for the disposal of washouts from concrete trucks and finishing; paint brushes and sprayers; oil and other petroleum spills; etc.

Conditions of Use

When other collection or containment options are not available.

Design and Installation Specifications

Containers should be lined with at least 10 mm thick liner or have secondary containment. Containers should be kept under a cover or have sufficient secondary containment capacity for a 10-year, 24-hour storm event.

Certain liquids or mixtures placed in the container will evaporate, leaving solids behind that may or may not require hazardous material disposal.

Maintenance Standards

Containers should be checked at least 3 times in a 48-hour period immediately following each use.

Containers should be checked weekly for spills or leaks. At the end of a project, washouts should:

- Have solids removed and properly disposed of.
- If liquids remain, they should be properly disposed of with other sanitary waste; per manufacturer's specifications; or as hazardous waste, if no other suitable option is available.

BMP 140: Qualified Site Official (QSO)

Purpose

The project proponent designates at least one qualified person as the responsible representative in charge of erosion and sediment control (ESC), and water quality protection. The designated person shall be the Qualified Site Official (QSO), who is responsible for ensuring compliance with all local, state, and federal erosion and sediment control and water quality requirements.

See Appendix F for additional information on training courses.

Conditions of Use

A QSO shall be made available on projects that discharge stormwater to surface waters of the state.

The QSO shall:

- Have a current certificate proving attendance in an ESC training course that meets the minimum ESC training and certification requirements established by ADEQ or the local municipality. ADEQ will maintain a list of ESC training and certification providers at: www.adeq.state.ar.us

OR

- Have a current certification as a Certified Professional in Erosion and Sediment Control (CPESC), Certified Erosion, Sediment, and Storm Water Inspector (CESSWI), Certified Professional in Storm Water Quality (CPSWQ), or Certified MS4 Specialist (CMS4S)

Specifications

- The QSO shall have authority to act on behalf of the contractor and/or developer and shall be on-call 24 hours per day throughout the life of the project.
- The Construction SWPPP shall include the name, telephone number, fax number, and address of the designated QSO.
- A QSO may provide inspection and compliance services for multiple construction projects in the same geographic region.

- Duties and responsibilities of the QSO shall include, but are not limited to the following:
 - Maintaining site permit file at all times including the SWPPP and any associated permits and plans.
 - Directing BMP installation, inspection, maintenance, modification, and removal.
 - Updating all project drawings and the Construction SWPPP to show any changes made.
 - Keeping daily logs, and inspection reports. Inspection reports should include:
 - Inspection date/time.
 - Weather information; general conditions during inspection and approximate amount of precipitation since the last inspection.
 - A summary or list of all BMPs implemented, including observations of all erosion/sediment control structures or practices.
 - Visual monitoring results, including a description of discharged stormwater. The presence of suspended sediment, turbid water, discoloration, and oil sheen shall be noted, as applicable.
 - Any water quality monitoring performed during inspection.
 - General comments and notes, including a brief description of any BMP repairs, maintenance or installations made as a result of the inspection.
 - Facilitate, participate in, and take corrective actions resulting from inspections performed by outside agencies or the owner.

BMP 150: Scheduling and Sequencing

Purpose

Sequencing a construction project reduces the amount and duration of soil exposed to erosion by wind, rain, runoff, and vehicle tracking.

Conditions of Use

The construction sequence schedule is an orderly listing of all major land disturbing activities together with the necessary erosion and sedimentation control measures planned for the project. This type of schedule guides the contractor on work to be done before other work is started so that serious erosion and sedimentation problems can be avoided.

Following a specified work schedule that coordinates the timing of land disturbing activities and the installation of control measures is perhaps the most cost-effective way of controlling erosion during construction. The removal of surface ground cover leaves a site vulnerable to accelerated erosion. Construction procedures that limit land clearing; provide timely installation of erosion and sedimentation controls; and restore protective cover quickly can significantly reduce the erosion potential of a site.

Design Considerations

- Avoid rainy periods.
- Schedule projects to disturb only small portions of the site at any one time. Complete grading as soon as possible. Immediately stabilize the disturbed portion before grading the next portion. Practice staged seeding in order to revegetate cut and fill slopes as the work progresses.

If extended wet periods delay the project schedule, revisions should be made so that everyone involved is kept current on which processes should be underway and which areas should be protected, treated, and/or stabilized.

BMP 170: Stormwater Pollution Prevention Plans

Purpose

SWP3s are to prevent the discharge of sediment and other pollutants to the maximum extent practicable from all ground-surface-disturbing projects.

Conditions of Use

A SWP3 is needed on all projects adding, replacing, disturbing, or clearing more than 1,000 square feet of ground surface.

Design and Installation Specifications

- Plan and implement proper clearing and grading of the site. It is most important only to clear the areas needed, thus keeping exposed areas to a minimum. Phase clearing so that only those areas that are actively being worked are uncovered. **Note: Clearing limits should be flagged in the lot or area prior to initiating clearing.**
- Soil shall be managed in a manner that does not permanently compact or deteriorate the final soil and landscape system. If disturbance and/or compaction occur, the impact must be corrected at the end of the construction activity. This shall include restoration of soil depth, soil quality, permeability, and % organic matter. Construction practices must not cause damage to or compromise the design of permanent landscape or infiltration areas.
- Locate excavated basement soil a reasonable distance behind the curb, such as in the backyard or side yard area. This will increase the distance eroded soil must travel to reach the storm sewer system.
- Soil piles should be covered until the soil is either used or removed. Piles should be situated so that sediment does not run into the street or adjoining yards.
- Backfill basement walls as soon as possible and rough grade the lot. This will eliminate large soil mounds, which are highly erodible, and prepares the lot for temporary cover, which will further reduce erosion potential.
- Remove excess soil from the site as soon as possible after backfilling. This will eliminate any sediment loss from surplus fill.
- If a lot has a soil bank higher than the curb, a trench or berm should be installed moving the bank several feet behind the curb. This will reduce the occurrence of gully and rill erosion while providing a storage and settling area for stormwater.
- The construction exit should be stabilized where traffic will be leaving the construction site and traveling on paved roads or other paved areas within 500 feet of the site.
- Provide for periodic street cleaning to remove any sediment that may have been tracked out. Sediment should be removed by shoveling or sweeping and carefully removed to a suitable disposal area where it will not be re-eroded.
- Utility trenches that run up and down slopes must be backfilled within 7 days.
- Cross-slope trenches may remain open throughout construction to provide runoff interception and sediment trapping, provided that they do not convey turbid runoff off-site.

Maintenance Standards

Chapter 2: Access and Source Control BMPs

BMP 201: High Visibility Plastic or Metal Fence

Purpose

Fencing is intended to:

- Restrict clearing to approved limits;
- Prevent disturbance of sensitive areas, their buffers, and other areas required to be left undisturbed;
- Limit construction traffic to designated construction entrances or roads; and
- Protect areas where marking with survey tape may not provide adequate protection.

Conditions of Use

To establish clearing limits, plastic or metal fence may be used:

- At the boundary of sensitive areas, their buffers, and other areas required to be left undisturbed.
- As necessary to control vehicle access to and within the site.

Design and Installation Specifications

- High visibility plastic fence shall be composed of a high-density polyethylene material and shall be at least 4'-0" in height. Posts for the fencing shall be steel or wood and placed every 6'-0" on center (max.), or as needed to ensure rigidity. The fencing shall be fastened to the post every 6" with a polyethylene tie. On long continuous runs of fencing, a tension wire or rope shall be used as a top stringer to prevent sagging between posts. The plastic fence color shall be high visibility orange. The fence tensile strength shall be 360 pounds per ft. using the ASTM D4595 testing method.
- Metal fences shall be designed and installed according to the manufacturer's specifications.
- Metal fences shall be at least 3'-0" high and must be marked in some way to make them highly visible.
- Fences shall not be wired or stapled to trees.

Maintenance Standard

If the fence has been damaged or visibility reduced, it shall be repaired or replaced immediately and visibility restored.

BMP 202: Stake and Wire Fence

Purpose

Fencing is intended to:

- Restrict clearing to approved limits;
- Prevent disturbance of sensitive areas, their buffers, and other areas required to be left undisturbed;
- Limit construction traffic to designated construction entrances or roads; and
- Protect areas where marking with survey tape may not provide adequate protection.

Conditions of Use

To establish clearing limits, plastic or metal fence may be used:

- At the boundary of sensitive areas, their buffers, and other areas required to be left undisturbed.

- As necessary to control vehicle access to and within the site.

Design and Installation Specifications

- See the figure below for details.
- More substantial fencing shall be used if the fence does not prevent encroachment into those areas that are not to be disturbed.

Maintenance Standards

If the fence has been damaged or visibility reduced, it shall be repaired or replaced immediately and visibility restored.

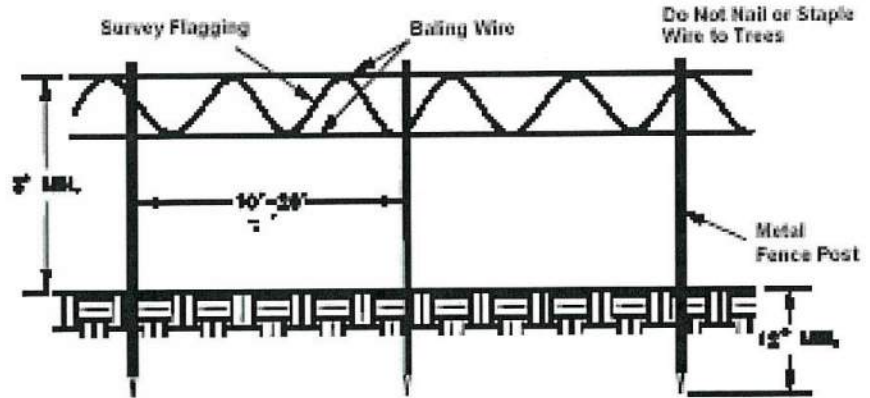

BMP 210: Stabilized Construction Exit

Purpose

Construction exits are stabilized to reduce the amount of sediment transported by vehicles or equipment leaving the site by constructing a stabilized pad at all possible access points to and from construction sites.

Conditions of Use

Construction exits shall be stabilized wherever traffic will be leaving a construction site and traveling on paved areas within 1,000 feet of the site.

Design and Installation Specifications

See the figure on the next page for details. **NOTE:** The minimum length of the entrance shall as close to the length required for 4 complete rotations of the largest wheel used during construction. This can be reduced to the maximum practicable size when the size or configuration of the site does not allow the full length (preferred length: 100').

- A separation geo-textile **shall** be placed under the pad to prevent fine sediment from pumping up into the pad. The geo-textile shall meet all the standards in the Table below.

Table 2: Geo-Textile Standards for Construction Exit Pads

Grab Tensile Strength (ASTM D4751):	200 psi min.
Grab Tensile Strength (ASTM D4632):	30% max.
Mullen Burst Strength (ASTM D3786-80a):	400 psi min.
AOS (ASTM D4751):	20-45 (U.S. standard sieve size)

- Consider early installation of the first lift of asphalt in areas that will be paved. This can be used as a stabilized exit. Also consider the installation of excess concrete as a stabilized exit.
- Fencing (see BMPs 201 and 202) shall be installed as necessary to restrict traffic to the construction entrances and exits. Whenever possible, the access point shall be constructed on a firm, compacted subgrade. This can substantially increase the effectiveness of the pad and reduce the need for maintenance.

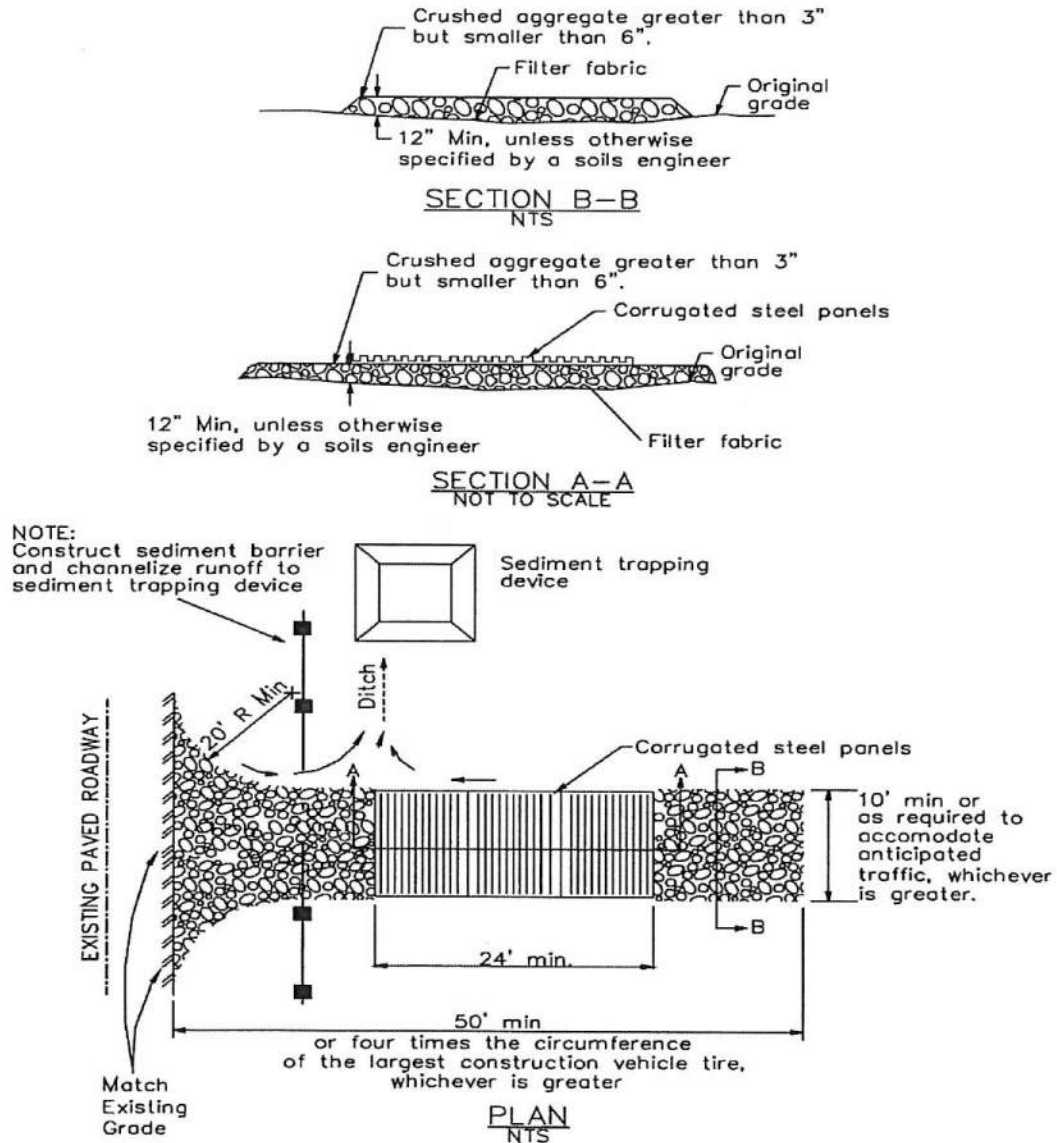

Maintenance Standards

- Crushed rock shall be added if the pad is no longer in accordance with the specifications.
- If the entrance is not preventing sediment from being tracked onto pavement, then alternative measures to keep the streets free of sediment shall be used. This may include, but is not limited to, an increase in the dimensions of the exit, the installation of a wheel wash, or street sweeping. Additional measures may be required if sediment continues to leave the site.
- Any sediment that is tracked onto pavement shall be removed by shoveling or street sweeping. The sediment collected by sweeping shall be replaced and stabilized on-site. The pavement shall **not** be cleaned by washing down the street, except when sweeping is ineffective and there is a

threat to public safety. If it is necessary to wash the streets, the construction of a small sump shall be considered. The sediment would then be washed into the sump where it can be controlled.

- Any rock that is loosened from the pad and which ends up on the roadway shall be removed immediately.
- If vehicles are entering or exiting the site at points other than the sites' controlled access locations, fencing (see BMPs 201 and 202) shall be installed to control traffic.
- Upon project completion and site stabilization, all construction accesses intended as permanent access for maintenance shall be permanently stabilized.

BMP 211: Rumble Strips and Wheel Washes

Purpose

Rumble strips and wheel washes reduce the amount of sediment transported by motor vehicles.

Conditions of Use

A rumble strip and/or wheel wash shall be used when a stabilized construction exit is not preventing sediment from being tracked onto pavement.

- A rumble strip is generally an effective BMP as long as the surface roughness is maintained to “knock” as much sediment as possible loose during the drive time over its surface.
- Wheel washing is generally an effective BMP when installed with careful attention to topography. For example, a wheel wash can be *detrimental* if installed at the top of a slope abutting a right-of-way where the water from the dripping truck can run unimpeded into the street.
- Pressure washing combined with an adequately sized and surfaced pad with direct drainage to a large 10'-0" x 10'-0" sump can be very effective.

Design and Installation Specifications

Rumble strips: Generally the same dimensions of a stabilized construction exit pad of 4" to 6" clean stone (aka B Stone) placed at least 8" thick over a geo-textile fabric with an area that has larger stones; reinforced fabric; or a metal grating that is sufficiently long enough to “rumble” off excessive amounts of sediment that has become attached to the vehicle, machinery, or equipment. See corrugated steel panels section shown in detail in BMP 210, Stabilized Construction Exit on previous page.

Wheel washes: Minimum dimensions are total length of 40'-0" by 12'-0" wide by 18" sump depth. The total length includes the ingress to and egress from the sump. The run-out pad should extend about 50'-0" past the egress ramp and drain back towards the sump or other acceptable collection, detention, and/or treatment facility. Fencing may be required to manage traffic.

The aggregate size of the pad should be 4" to 6" clean stone (aka B Stone) placed at least 8" thick over a geo-textile fabric to prevent muddying of the stone from the subgrade level and to improve stability. An alternative would be to place a 3" asphalt lift over a stable roadway base or a minimum of 6" of asphalt treated base (ATB) over crushed base material. A good, solid subgrade is recommended for the wheel wash.

Keep the water level from 12" to 14" deep to avoid damage to truck hubs and filling the truck tongues with water. Use a low clearance truck to test the wheel wash before paving. Either a belly dump or lowboy will work well to test clearance. Midpoint spray nozzles are only needed in extremely muddy conditions.

Wheel wash systems should be designed with a small grade change (6"-12" for a 10'-0" wide pond) to allow sediment to flow to the low side of pond to help prevent re-suspension of sediment. A drainpipe

with a 2'-0" to 3'-0" riser should be installed on the low side of the pond to allow for easy cleaning and refilling. Polymers may be used to promote coagulation and flocculation in a closed-loop system. PAM (see BMP 226) added to the wheel wash water at a rate of 0.25 - 0.5 pounds per 1,000 gallons of water increases effectiveness and reduces cleanup time. If PAM is already being used for dust or erosion control and is being applied by a water truck, the same truck can be used to change the wash water.

Suggested details are shown in the figure below with the part labels shown. Various cities may allow other designs.

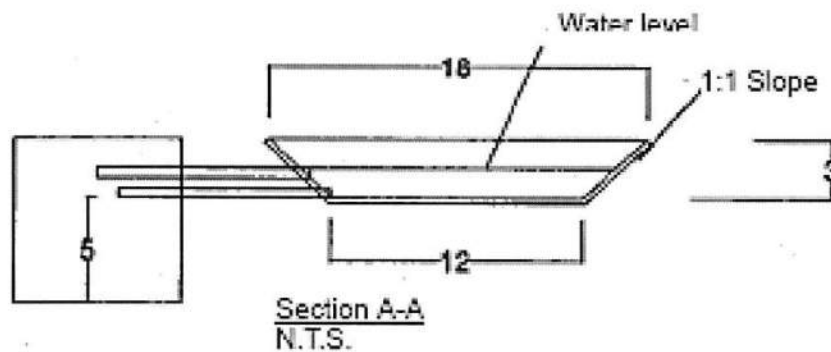
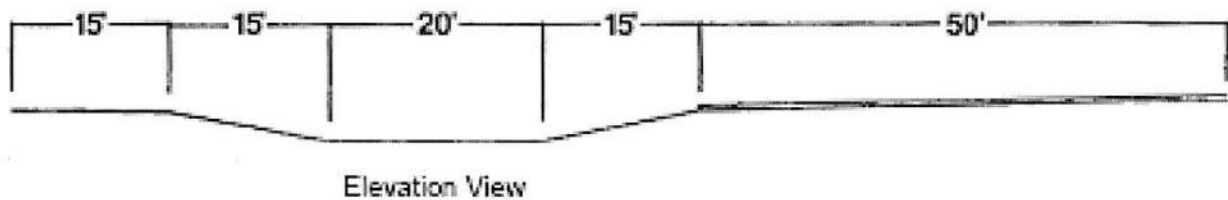
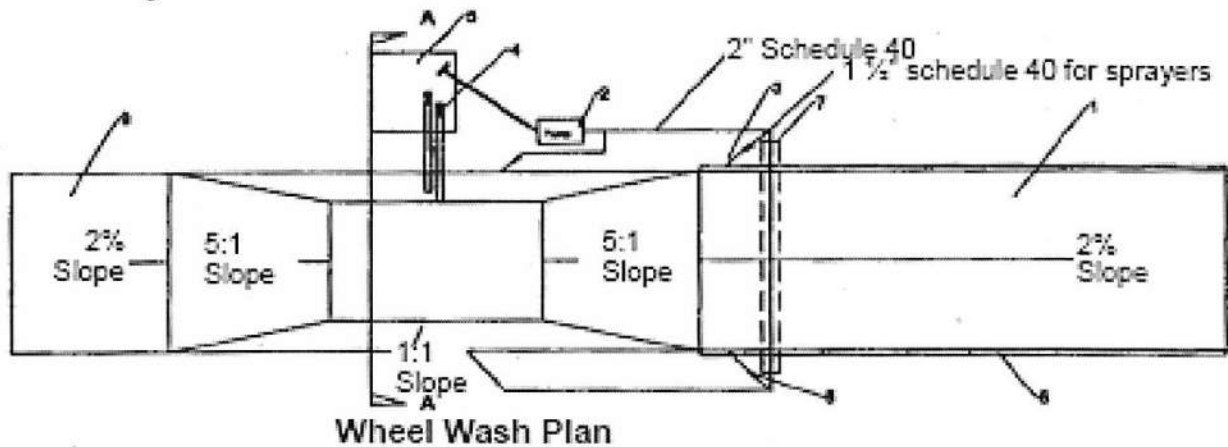

1. Run-out pad
2. Trash pump with floats
3. Midpoint spray nozzles, if needed
4. Sewer pipe with butterfly valves; locate top pipe's invert 12" above bottom of wheel wash
5. Sump with catch basin
6. Direct water back to pond
7. Sleeve under road
8. Ball valves
9. Apron to protect from splashing water

Maintenance Standards

- The wheel wash should start out the day with fresh water. The wash water should be changed a minimum of once per day. On large earthwork jobs where more than 10-20 trucks per hour are expected, the wash water will need to be changed more often. Wheel wash or tire bath wastewater shall be discharged to a separate on-site treatment system, such as closed-loop recirculation or land application.
- The sump and collection/treatment facility needs to be inspected at least weekly to check for proper drainage; depth of accumulated sediment; any areas that require maintenance; and to make sure that the collection and/or treatment processes are correctly functioning.
- Water levels in the sump need to be verified several times a day to keep at a working level and clarity.
- The ingress and egress pads need to be reviewed weekly for the need to re-grade, or to remove sediment that is clogging or has accumulated on the travel path. If stone has been carried away from the pad, it may need to be replaced. If accumulated sediment can not be removed by washing, pumping, or vacuuming, the area may require complete removal and replacement. Pumped or vacuumed sediment should be either hauled off-site to a licensed waste facility or replaced for re-used on-site.

BMP 212: Construction Road and Parking Area Stabilization

Purpose

Stabilizing entrances, roads, other on-site vehicle routes, and parking areas immediately after grading will reduce the amount of erosion caused by construction traffic.

Mats and pads are available to provide reusable alternatives to rock or paved surfaces that are to be returned to “green” surface conditions.

Conditions of Use

- All areas shall be stabilized wherever they are constructed, whether permanent or temporary, for use by construction traffic.
- Roads or parking areas shall be stabilized wherever they are constructed, whether permanent or temporary, for use by construction traffic.
- Fencing (see BMPs 201 and 202) shall be installed, if necessary, to limit the access of vehicles to only those roads and parking areas that are stabilized.

Design and Installation Specifications

- Reusable mats and pads can be purchased in fiber or plastic rolls; or constructed on-site of plant fibers in planks, pipes, tubes, or channels and placed in locations where equipment travels or sits in an areas that is “soft,” “boggy,” muddy, or similar condition that can be tracked off-site.
- On areas that will receive asphalt as part of the project, install the first lift as soon as possible.
- A 6” depth of 2” to 4” crushed rock, gravel base, or crushed surfacing base course shall be applied immediately after grading or utility installation. A 4” course of ATB may also be used, or the road and/or parking area may be paved. It may also be possible to use cement or calcium chloride for soil stabilization. If cement or cement kiln dust is used for road base stabilization, pH monitoring and BMPs are necessary to evaluate and minimize the effects on stormwater. Whenever possible, construction roads and parking areas shall be placed on a firm, compacted subgrade.
- Temporary road gradients shall not exceed 15%. Roadways shall be carefully graded to drain. Drainage ditches shall be provided on each side of the roadway in the case of a crowned section,

or on one side in the case of a super-elevated section. Drainage ditches shall be directed to a sediment control BMP.

- Rather than relying on ditches, it may also be possible to grade the road so that runoff sheet-flows into a heavily vegetated area with a well-developed topsoil. Landscaped areas are not adequate. If this area has at least 50'-0" of vegetation, then it is generally preferable to use the vegetation to treat runoff, rather than to build a sediment pond or trap. The 50'-0" strip shall **not** include wetlands. If runoff is allowed to sheet flow through adjacent vegetated areas, it is vital to design the roadways and parking areas so that no concentrated runoff is created.
- Storm drain inlets shall be protected to prevent sediment-laden water entering the storm drain system (see BMP 320).

Maintenance Standards

- Inspect stabilized areas regularly, especially after large storm events.
- Crushed rock, gravel base, hog fuel, etc. shall be added as required to maintain a stable driving surface and to stabilize any areas that have eroded.
- Following construction, these areas shall be restored to pre-construction condition or better to prevent future erosion.
- If a reusable mat or pad is used and depending on what it is made of, the item can be cleaned, "packaged," and transported to another site for multiple years or can be recycled into another product.

BMP 220: Temporary and Permanent Seeding

Purpose

Seeding is intended to reduce erosion by stabilizing exposed soils. A well-established vegetative cover is one of the most effective methods of reducing erosion.

Conditions of Use

- Seeding may be used throughout the project on disturbed areas that have reached final grade or that will not be worked for more than 30 days.
- Channels that will be vegetated should be installed before major earthwork and hydro-seeded with a BFM. The vegetation should be well established (i.e., more than 75% cover) before water is allowed to flow in the ditch. With channels that will have high flows, erosion control blankets should be installed over the hydro-seed. If vegetation cannot be established from seed before water is allowed in the ditch, sod should be installed in the bottom of the ditch over hydro-mulch and blankets.
- Retention/detention ponds should be seeded or sodded as required.
- Mulch is required at all times because it protects seeds from heat, moisture loss, and transport due to runoff.
- All disturbed areas shall be inspected in late August to early September and all seeding should be completed by the end of September. Otherwise, vegetation will not establish itself enough to provide more than average protection.
- At final site stabilization, all disturbed areas not otherwise vegetated or stabilized shall be seeded and mulched. Final stabilization means the completion of all soil disturbing activities at the site and the establishment of a permanent vegetative cover, or equivalent permanent stabilization measures (such as pavement, native stone, gabions or geo-textiles) which will prevent erosion.

Design and Installation Specifications

- Seeding should be done during those seasons most conducive to growth and will vary with the climate conditions of the region.
- The optimum seeding windows for Arkansas are April 1 through June 30 and September 1 through October 1. Seeding that occurs between July 1 and August 30 will require irrigation until over 75% cover is established. Seeding that occurs between October 1 and March 30 will require a mulch or plastic cover until 75% grass cover is established.
- To prevent seed from being washed away, blankets or netting may be required. All required surface water control measures should also be confirmed that they have been correctly installed.
- The seedbed should be firm and rough. All soil should be roughened no matter what the slope. If compaction is required for engineering purposes, slopes must be track-walked before seeding. Back-blading or smoothing of slopes greater than 4:1 is not allowed if they are to be seeded.
- New and more effective restoration-based landscape practices rely on deeper incorporation than is provided by a simple single-pass roto-tilling treatment. Whenever practical, the subgrade should be initially ripped to improve long-term permeability, infiltration, and water inflow qualities. At a minimum, permanent areas shall use soil amendments to achieve organic matter and permeability performance defined in engineered soil/landscape systems. For systems that are deeper than 8", the roto-tilling process should be done in multiple lifts, or the soil system shall be properly prepared and then placed to achieve the specified depth.
- Organic matter is the most appropriate form of "fertilizer" because it provides nutrients (including nitrogen, phosphorus, and potassium) in the least water-soluble form. A natural system typically releases 2%-10% of its nutrients annually. Chemical fertilizers have been formulated to simulate what organic matter does naturally.
- In general, a 10-4-6 N-P-K (nitrogen-phosphorus-potassium) fertilizer can be used at a rate of 90 pounds per acre. Slow-release fertilizers are preferred since they are more efficient with fewer environmental impacts.
- It is recommended that areas being seeded for final landscaping conduct soil tests to determine the exact type and quantity of fertilizer needed. Fertilizer should not be added to the hydro-mulch machine and agitated for more than 20 minutes before it is to be used. If the fertilizer is agitated too much, the slow-release coating will be destroyed.
- There are numerous products available that can take the place of chemical fertilizers. These include several with seaweed extracts that are beneficial to soil microbes and organisms. If 100% cottonseed meal is used as the mulch in hydro-seed, a chemical fertilizer may not be necessary. Cottonseed meal is a good source of long-term, slow-release, available nitrogen.
- Hydro-seed applications shall include a minimum of 1,500 pounds per acre of mulch with 3% tackifier. Mulch may be made up of 100% cottonseed meal; fibers made of wood, recycled cellulose, hemp, other plant-fibers; compost; or blends of these. Tackifier shall be plant-based (such as guar or alpha plantago), or may be chemical-based (such as PAM or polymers). Any mulch or tackifier product used shall be installed per manufacturer's instructions. Seed and fertilizer are added at time of application.
- Mulch is always required for seeding. Mulch can be applied on top of the seed or simultaneously by hydro-seeding.
- The seed mix shown in Table 3 on the top of the next page is a recommended low-growing, relatively non-invasive seed mix appropriate for very wet areas that are not regulated wetlands. Other mixes may be appropriate, depending on the soil type and hydrology of the area. Recent research suggests that bent grass (*agrostis sp.*) should be emphasized in wet-area seed mixes. Apply this mixture in Table 3 at a rate of 60 pounds per acre.

Table 3: Wet Area Seed Mix*

	% by Weight	% Seed Purity	Germination Rate
Tall or meadow fescue	60%-70%	98%	90%
Seaside/Creeping bent grass	10%-15%	98%	85%
Meadow foxtail	10%-15%	90%	80%
Alsike clover	1% - 6%	98%	90%
Redtop bent grass	1% - 6%	92%	85%

*from Modified Briargreen Inc.; Hydro-seeding Guide Wetlands Seed Mix

The meadow seed mix in Table 4 below is recommended for areas that will be maintained infrequently (or not at all) and where colonization by native plants is desirable. Likely applications include rural road and utility rights-of-way. Seeding should take place in September or very early October in order to obtain adequate establishment prior to the winter months. The appropriateness of clover in the mix may need to be considered, as this can be a fairly invasive species. If the soil is amended, the addition of clover may not be necessary.

Table 4: Meadow Seed Mix

	% by Weight	% Seed Purity	Germination Rate
Redtop bentgrass	20%	92%	85%
Red fescue	70%	98%	90%
White Dutch clover	10%	98%	90%

Maintenance Standards

- Any seeded areas that fail to establish over 80% cover (100% cover for areas that receive sheet or concentrated flows) shall be reseeded. If reseeding is ineffective, an alternate method (such as sodding, mulching, netting, or blankets) shall be used. If winter weather prevents adequate grass growth, this time limit may be relaxed at the discretion of the local authority when sensitive areas would otherwise be protected.
- After adequate cover is achieved, any areas that experience erosion shall be reseeded and protected by mulch. If the erosion problem is drainage-related, the problem shall be fixed and the eroded area reseeded and protected by mulch.
- Seeded areas shall be supplied with adequate moisture, but not watered to the extent that it causes runoff.

BMP 221: Mulching

Purpose

The purpose of mulching soils is to provide immediate temporary protection from erosion. Mulch also enhances plant establishment by conserving moisture; holding fertilizer, seed, and topsoil in place; and moderating soil temperatures. There is an enormous variety of mulches that are available. Only the most common types are discussed in this section.

Conditions of Use

As a temporary cover measure, mulch should be used:

- On disturbed areas that require cover measures for less than 30 days
- As a cover for seed during the wet season and during the hot summer months
- During the wet season on slopes steeper than 3:1 that have more than a 10’-0” of vertical relief

Mulch may be applied at any time of the year and should be refreshed periodically.

Design and Installation Specifications

For mulch materials, application rates, and specifications, see the Table 5 on the next page.

Table 5: Mulch Standards and Guidelines

Material	Quality Standards	Application Rate	Remarks
Straw	Air-dried: free from undesirable seed and course material	2" to 3" thick uses one bale per 200 square feet OR 2 to 3 tons per acre	Cost-effective protection when applied with adequate thickness. Hand-application requires greater thickness than if blown. The thickness of straw may be reduced by 50% when used with seed. In windy areas, it must be held in place by crimping, using a tackifier, or covering with netting. Blown straw always has to be held in place with a tackifier or will blow it away. Has several deficiencies to be considered when selecting. Often introduces and/or encourages the propagation of weed species. It has no long term benefits. Straws should be used only if mulches with long term benefits are unavailable locally. It should also not be used within the ordinary high-water elevation of surface waters (due to flotation).
Hydro-Mulch	No growth inhibiting factors	About 25 to 30 pounds per 1,000 square feet OR 1,500 to 2,000 pounds per acre	Shall be applied with appropriate equipment. Shall not be used without seed and tackifier unless the application rate is at least doubled. Fibers should be kept to less than 3/4" to prevent clogging of machinery.
Compost And Composted Mulch	No visible water or dust during handling. Purchase from supplier with Solid Waste Permit or exempt from solid waste regulations	2" thick min. uses about 100 tons per acre OR 800 lbs per square yard	More effective control can be obtained by increasing thickness to 3". Excellent for protecting final grades until landscaping because it can be directly seeded or tilled into soil as an amendment. Composted mulch has a coarser size gradation than compost. More stable and practical to use in wet areas and during rainy weather conditions.
Chipped Site Vegetation	Average size shall be several inches long. Gradation from fines to 6" in length for texture, variation, and interlocking properties.	2" thick min.	Cost effective way to dispose of debris from clearing and grubbing. Eliminates the problems associated with burning. Generally it should not be used on slopes above 20% because tends to be transported by runoff. Not recommended within 200 feet of surface waters. If seeding is expected shortly after mulch, the decomposition may tie up nutrients important to grass establishment.
Wood-based mulch	No visible water or dust during handling. Purchase from supplier with Solid Waste Permit or exempt from solid waste regulations.	2" thick min. uses about 100 tons per acre OR 800 lbs per square yard	Often called "hog fuel." Used as a material for stabilized construction exits (BMP 210) and as a mulch. Its use as mulch ultimately improves the organic matter in the soil. Special caution is advised regarding the source and composition of wood-based mulches. Its preparation typically does not provide any weed seed control, so evidence of residual vegetation in its composition or known inclusion of weed plants or seeds should be monitored and prevented (or minimized).

NOTE: Thicknesses may be increased for disturbed areas in or near sensitive areas or other areas highly susceptible to erosion. Mulch used within the ordinary high-water mark of surface waters should be selected to minimize potential flotation of organic matter. Composted organic materials have higher densities than straw, wood, plant fibers, or other chipped material.

Maintenance Standards

- The thickness of the cover must be maintained.
- Any areas that experience erosion shall be re-mulched and/or protected with a net or blanket. If the erosion problem is drainage-related, then the problem shall be fixed and the eroded area re-mulched.
- Wind and concentrated runoff flows can dislodge, remove, and/or wash mulch from its application area.
- Inspection is required after each rainfall event to check for stability of mulch and required coverage until the site has been stabilized.
- After site stabilization, inspection should occur at least per quarter and after every unusually large storm.

BMP 230: Nets and Blankets***Purpose***

Erosion control nets and blankets are intended to prevent erosion and hold seed and mulch in place on steep slopes and in channels so that vegetation can become well established. In addition, some nets and blankets can be used to permanently reinforce turf to protect drainage ways during high flows. Nets (also called mats) are strands of material woven into an open, but high-tensile strength net (for example, coconut fiber matting). Blankets are strands of material that are not tightly woven, but instead form a layer of interlocking fibers, typically held together by a bio-degradable or photo-degradable netting (for example, excelsior or straw blankets). They generally have lower tensile strength than nets, but cover the ground more completely. Coir (coconut fiber) fabric comes as both nets and blankets.

Nets and blankets often have the option to be pre-seeded, fertilized, and/or mulched which can simply installation or reduce time and labor required for all 3 steps.

Conditions of Use

Erosion control nets and blankets should be used:

- To aid permanent vegetated stabilization of slopes 2:1 or greater and with more than 10'-0" of vertical relief, and/or
- For drainage ditches and swales (highly recommended).

The application of appropriate netting or blanket to drainage ditches and swales can protect bare soil from channelized runoff while vegetation is established. Nets and blankets also can capture a great deal of sediment due to their open, porous structure. Synthetic nets and blankets can be used to permanently stabilize channels and may provide a cost-effective, environmentally preferable alternative to native stone. 100% synthetic blankets manufactured for use in ditches may be easily reused as temporary ditch liners.

Disadvantages of blankets include:

- Surface preparation required;
- On slopes steeper than 2.5:1, blanket installers may need to be roped and harnessed for safety;
- They can cost \$4,000-6,000 per acre installed. Incorrect installations cost more due to repeated repairs and/or replacements.

Advantages of blankets include:

- Can be installed without mobilizing special equipment;
- Can be installed by anyone with minimal training;
- Can be installed in stages or phases as the project progresses;
- Seed and fertilizer can be hand-placed by the installers as they progress down the slope;
- Can be installed in any weather;

- The numerous types of blankets with various parameters in mind. Those parameters include: fiber blend, mesh strength, longevity, cost, availability and bio-degradability.

Design and Installation Specifications

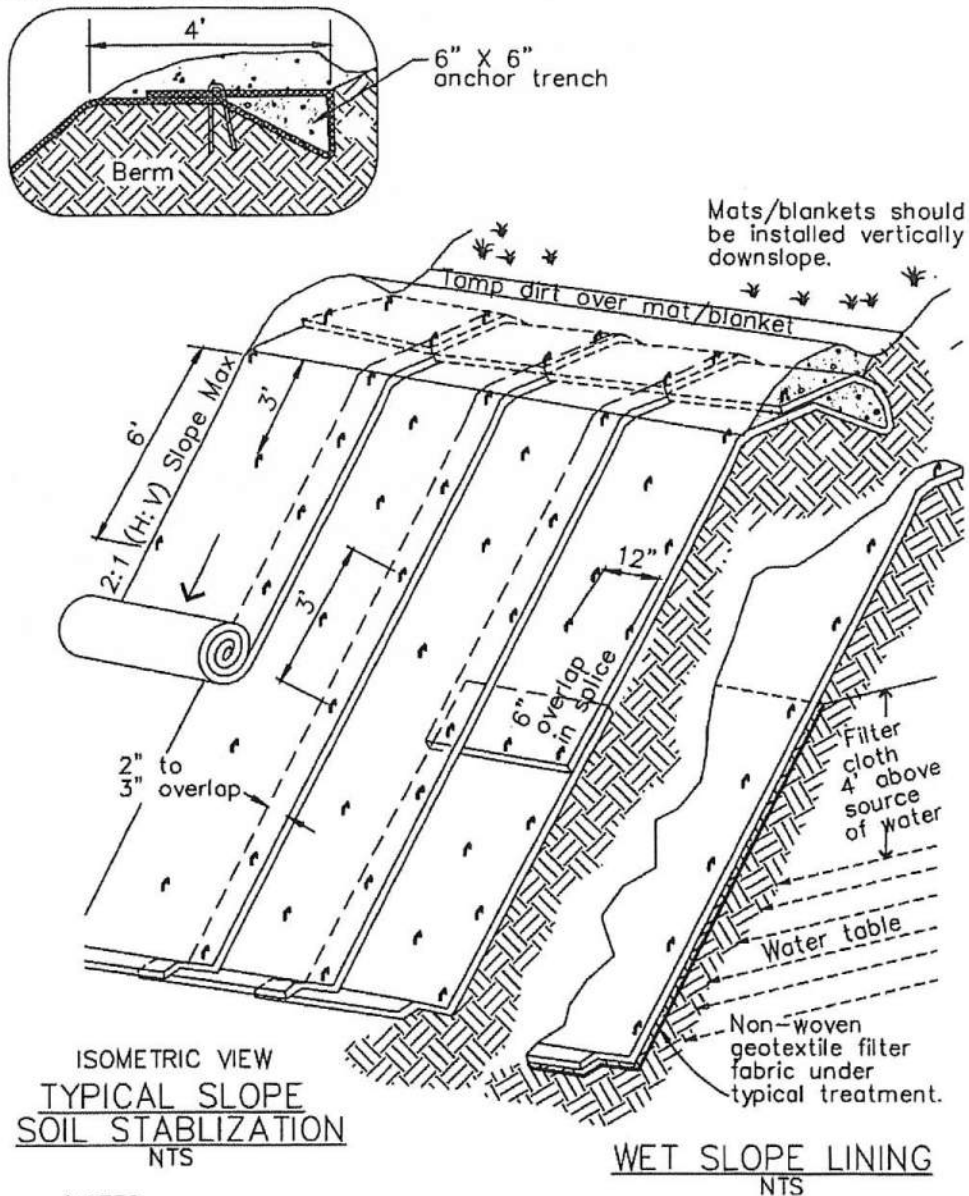

- Installation is critical to the effectiveness of these products. If good ground contact is not achieved, runoff can concentrate under the product, resulting in significant erosion.
- Installation of Blankets on Slopes:
 1. Complete final grade and track walk up and down the slope.
 2. Install hydro-mulch with seed and fertilizer.
 3. Dig a small trench, approximately 12" wide by 6" deep along the top of the slope.
 4. Install the leading edge of the blanket into the small trench and staple approximately every 18".
NOTE: Staples are: either metal or plastic; "U"-shaped; and a minimum of 6" long. Longer staples are used in sandy soils. Bio-degradable stakes are also available.
 5. Roll the blanket slowly down the slope as installer walks backwards. **NOTE:** The blanket rests against the installer's legs. Staples are installed as the blanket is unrolled. It is critical that the

proper staple pattern is used for the blanket being installed. The blanket is not to be allowed to roll down the slope on its own as this stretches the blanket and makes it impossible to maintain soil contact. In addition, no one should be allowed to walk on the blanket after it is in place.

6. If the blanket is not long enough to cover the entire slope length, the trailing edge of the upper blanket should overlap the leading edge of the lower blanket and be stapled. On steeper slopes, this overlap should be installed in a small trench, stapled, and covered with soil.

- It is critical that the design engineer consults the manufacturer's information and that a site visit takes place in order to insure that the product specified is appropriate.
- Jute matting must be used in conjunction with mulch (BMP 221). Woven blankets, excelsior, and coir (coconut fiber) blankets may be installed without mulch. There are many other types of erosion control nets and blankets on the market that may be appropriate in certain circumstances.
- In general, most nets require mulch in order to prevent erosion because they have a fairly open structure. Blankets typically do not require mulch because they provide complete protection of the surface.
- Extremely steep, unstable, wet, or rocky slopes are often appropriate candidates for use of synthetic

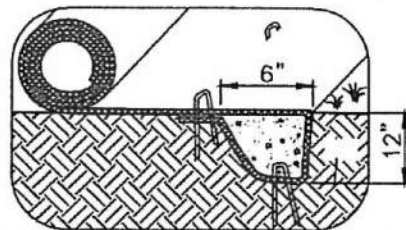

INITIAL CHANNEL ANCHOR TRENCH
NTS

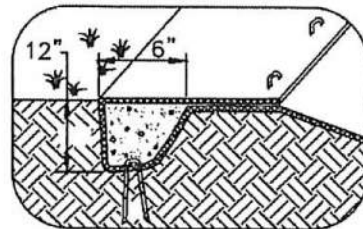

TERMINAL SLOPE AND CHANNEL ANCHOR TRENCH
NTS

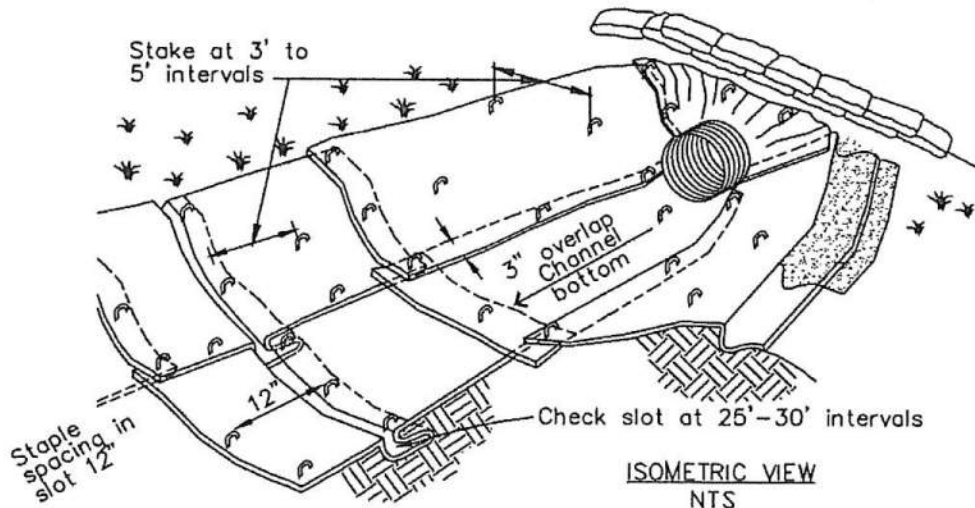

ISOMETRIC VIEW
NTS

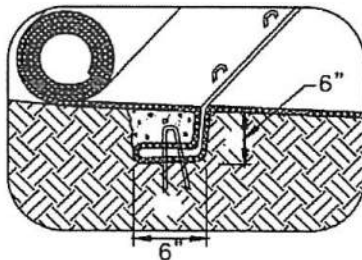

INTERMITTENT CHECK SLOT
NTS

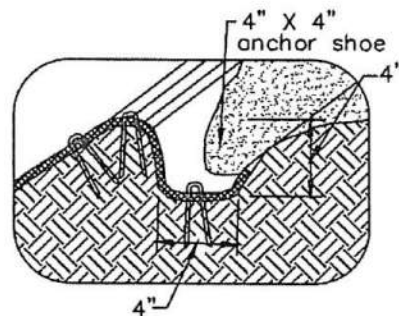

LONGITUDINAL ANCHOR TRENCH
NTS

blankets, in addition to riverbanks, beaches and other high-energy environments. If synthetic blankets are used, the soil should be hydro-mulched first.

- 100% bio-degradable blankets are available for use in sensitive areas. These organic blankets are usually held together with a paper or fiber mesh and stitching which may last up to a year.
- Most netting used with blankets is photo-degradable, meaning they break down under sunlight. However, this process can take months or years even under bright sun. Once vegetation is established, sunlight does not reach the mesh. It is not uncommon to find non-degraded netting still in place several years after installation. This can be a problem if maintenance requires the use of mowers or ditch cleaning equipment. In addition, birds and small animals can become trapped in the netting.
- See the figures on the 2 previous page for typical orientation and installation of blankets used in channels and as slope protection. **NOTE:** These are typical details only. All blankets must be installed per manufacturer's installation instructions.

Maintenance Standards

- Good contact with the ground must be maintained, and erosion must not occur beneath the net or blanket.
- Any areas of the net or blanket that are damaged or that are not in close contact with the ground shall be repaired, replaced, and/or stapled.
- If erosion occurs due to poorly controlled drainage, the problem shall be fixed and the eroded area protected.
- Inspection is required after every rain event until the entire area has been stabilized.
- Improper anchoring and/or installation can result in erosion underneath; washing away of the blanket or net; or complete failure of the slope.

BMP 240: Sodding

Purpose

The purpose of sodding is to establish permanent turf for immediate erosion protection and to stabilize drainage ways where concentrated overland flow will occur.

Conditions of Use

Sodding may be used in the following areas:

- Disturbed areas that require short-term or long-term cover.
- Disturbed areas that require immediate vegetative cover.
- All waterways that require vegetative lining. Waterways may also be seeded rather than sodded, and protected with a net or blanket.

Design and Installation Specifications

Sod shall be free of weeds, of uniform thickness (approximately 1" thick), and shall have a dense root mat for mechanical strength.

The following steps are recommended for sod installation:

1. Shape and smooth the surface to final grade in accordance with the approved grading plan. The swale needs to be over excavated 4" to 6" below design elevation to allow room for placing soil amendment and sod.
2. Amend 4" (min.) of compost into the top 8" of the soil if the organic content of the soil is less than 10% or the permeability is slower than 0.6" per hour.
3. Fertilize according to the supplier's recommendations.
4. Work lime and fertilizer 1" to 2" into the soil, and smooth the surface.
5. Lay strips of sod beginning at the lowest area to be sodded and perpendicular to the direction of

water flow. Wedge strips securely into place. Square the ends of each strip to provide for a close, tight fit. Stagger joints at least 12". Staple on slopes steeper than 3:1. Staple the upstream edge of each sod strip.

6. Roll the sodded area and irrigate.

7. When sodding is carried out in alternating strips or other patterns, seed the areas between the sod pieces immediately after finishing with the sod.

Maintenance Standards

If the grass is unhealthy, the cause shall be determined and appropriate action taken to reestablish a healthy groundcover. If it is impossible to establish a healthy groundcover due to frequent saturation, instability, or some other cause, the sod shall be removed. The area should then be seeded with an appropriate mix and protected with a net or blanket.

BMP 241: Topsoiling

Purpose

To provide a suitable growth medium for final site stabilization with vegetation. While not a permanent cover practice in itself, topsoiling is an integral component of providing permanent cover in those areas where there is an unsuitable soil surface for plant growth. Native soils and disturbed soils that have been organically amended not only retain much more stormwater, but they also serve as effective bio-filters for urban pollutants and, by supporting more vigorous plant growth, reduce the water, fertilizer and pesticides needed to support installed landscapes. Topsoil does not include any subsoils, but only the material from the top several inches including organic debris.

Conditions of Use

- Native soils should be left undisturbed to the maximum extent practicable. Native soils disturbed during clearing and grading should be restored, to the maximum extent practicable, to a condition where moisture-holding capacity is equal to or better than the original site conditions. This criterion can be met by using on-site native topsoil, incorporating amendments into on-site soil, or importing blended topsoil.
- Topsoiling is a required procedure when establishing vegetation on shallow soils, and soils of critically low pH (high acid) levels.
- Stripping of existing, properly functioning soil system and vegetation for the purpose of topsoiling during construction is not acceptable. If an existing soil system is functioning properly it shall be preserved in its undisturbed and uncompacted condition.
- Depending on where the topsoil comes from, or what vegetation was on site before disturbance, invasive plant seeds may be included and could cause problems for establishing native plants, landscaped areas, or grasses.
- Topsoil from the site will contain mycorrhizal bacteria that are necessary for healthy root growth and nutrient transfer. These native mycorrhizal are acclimated to the site and will provide optimum conditions for establishing grasses. Commercially available mycorrhiza products should be used when topsoil is brought in from off-site.

Design and Installation Specifications

If topsoiling is to be done, the following items should be considered:

- Maximize the depth of the topsoil wherever possible to provide the maximum possible infiltration capacity and beneficial growth medium. Topsoil depth shall be at least 8" with a minimum organic content of 10% dry weight and pH between 6.0 and 8.0 or matching the pH of the undisturbed soil. This can be accomplished either by returning native topsoil to the site and/or incorporating organic

amendments. Organic amendments should be incorporated to a minimum 8" depth except where tree roots or other natural features limit the depth of incorporation. Subsoils below the 12" depth should be scarified at least 2" to avoid stratified layers, where feasible. The decision to either layer topsoil over a subgrade or incorporate topsoil into the underlying layer may vary depending on the planting specified.

- If blended topsoil is imported, then fines should be limited to 25% passing through a #200 sieve.
- The final composition and construction of the soil system will result in a natural selection or favoring of certain plant species over time. For example, recent practices have shown that incorporation of topsoil may favor grasses, while layering with mildly acidic, high-carbon amendments may favor more woody vegetation.
- Locate the topsoil stockpile so that it meets specifications and does not interfere with work on the site. It may be possible to locate more than one pile in proximity to areas where topsoil will be used.
- Allow sufficient time in scheduling for topsoil to be spread prior to seeding, sodding, or planting.
- Care must be taken not to apply to subsoil if the two soils have contrasting textures. Sandy topsoil over a clay subsoil is a particularly poor combination, as water creeps along the junction between the soil layers and causes the topsoil to slough.
- If topsoil and subsoil are not properly bonded, water will not infiltrate the soil profile evenly and it will be difficult to establish vegetation. The best method to prevent a lack of bonding is to actually work the topsoil into the layer below for a depth of at least 6".
- Ripping or re-structuring the subgrade may also provide additional benefits regarding the overall infiltration and interflow dynamics of the soil system. Field exploration of the site shall be made to determine if there is surface soil of sufficient quantity and quality to justify stripping. Topsoil shall be friable and loamy (loam, sandy loam, silt loam, sandy clay loam, clayey loam). Areas of natural ground water recharge should be avoided.
- Stripping shall be confined to the immediate construction area. A 4" to 6" stripping depth is common, but depth may vary depending on the particular soil. All surface runoff control structures shall be in place prior to stripping. Stockpiling of topsoil shall occur in the following manner:
 - Side slopes of the stockpile shall not exceed 2:1.
 - An interceptor dike with gravel outlet and silt fence shall surround all topsoil stockpiles between October 1 and April 30. Between May 1 and September 30, an interceptor dike with gravel outlet and silt fence shall be installed if the stockpile will remain in place for a longer period of time than active construction grading.
 - Erosion control seeding or covering with clear plastic or other mulching materials of stockpiles shall be completed within 2 days (October 1 through April 30) or 7 days (May 1 through September 30) of the formation of the stockpile. Native topsoil stockpiles shall not be covered with plastic. Topsoil shall not be placed while in a frozen or muddy condition, when the subgrade is excessively wet, or when conditions exist that may otherwise be detrimental to proper grading or proposed sodding or seeding.
- Previously established grades on the areas to be topsoiled shall be maintained according to the approved plan.
- When native topsoil is to be stockpiled and reused the following should apply to ensure that the mycorrhizal bacterial, earthworms, and other beneficial organisms will not be destroyed:
 1. Topsoil is to be re-installed within 4 to 6 weeks;
 2. Topsoil is not to become saturated with water;
 3. Plastic cover is not allowed.

Maintenance Standards

Inspect stockpiles regularly, especially after large storm events. Stabilize any areas that have eroded.

BMP 250: Poly-acryl amide (PAM) for Soil Erosion Protection

Purpose

Poly-acryl amide (PAM) is used on construction sites to prevent soil erosion. Applying PAM to bare soil in advance of a rain event significantly reduces erosion and controls sediment in 2 ways. First, PAM increases the soil’s available pore volume, thus increasing infiltration and reducing the quantity of stormwater runoff. Second, it increases flocculation of suspended particles and aids in their deposition, thus reducing stormwater runoff turbidity and improving water quality.

PAM used for coagulation or flocculation of sediment pond waters helps remove solids (such as sediment or organic materials) that have been picked up during stormwater runoff of areas above the pond. See Chapter 4 BMPs and Appendix D for additional information on chemical treatments and ponds.

Conditions of Use

PAM shall not be directly applied or allowed to enter a water body. In areas that drain to a sediment pond, PAM can be applied to bare soil under the following conditions:

- During rough grading operations
- Staging areas
- Balanced cut and fill earthwork
- Haul roads prior to placement of crushed rock surfacing
- Compacted soil road base
- Stockpiles
- After final grade and before paving or final seeding and planting
- Pit sites
- Sites having a winter shut down.

In the case of winter shut down, or where soil will remain unworked for several months, PAM should be used with mulch.

Design and Installation Specifications

Not all jurisdictions allow anything other than water to control dust.

PAM may be applied dissolved in water, or it may be applied as a dry grain or powder. The preferred application method is the dissolved form. PAM should be applied at a maximum rate of 80 mg/L per 1 acre of bare soil.

The table below can be used to determine the PAM and water application rate for a disturbed soil area. Higher concentrations of PAM **do not** provide any additional effectiveness.

Table 6: PAM and Water Application rates

Disturbed Area	PAM	Water
0.50 acres	0.33 lbs	500 gallons
1.00 acres	0.66 lbs	1,000 gallons
1.50 acres	1.00 lbs	1,500 gallons
2.00 acres	1.32 lbs	2,000 gallons
2.50 acres	1.65 lbs	2,500 gallons
3.00 acres	2.00 lbs	3,000 gallons
3.50 acres	2.33 lbs	3,500 gallons
4.00 acres	2.65 lbs	4,000 gallons
4.50 acres	3.00 lbs	4,500 gallons
5.00 acres	3.33 lbs	5,000 gallons

The Preferred Application Method:

- Pre-measure the area where PAM is to be applied and, using the table above, calculate the amount of product and water necessary to provide coverage.

- PAM has infinite solubility in water, but dissolves very slowly. Dissolve pre-measured dry granular PAM with a known quantity of clean water in a bucket several hours or overnight before applying. Mechanical mixing will help dissolve the PAM. Always add PAM to water - not water to PAM.
- Pre-fill the water tank about 1/8 full with water. The water does not have to be potable, but it must have relatively low turbidity – in the range of 20 NTU or less.
- Add PAM-water mixture to the tank
- Completely fill the water truck to specified volume.
- Spray the final PAM solution onto dry soil until the soil surface is uniformly and completely wetted.

An Alternate Application Method:

PAM may also be applied as a powder at the rate of 5 pounds per acre. This must be applied on a day that is dry. For areas less than 5-10 acres in size, a hand-held “organ grinder” fertilizer spreader set to the smallest setting will work best. Tractor-mounted spreaders will work for larger areas.

The following shall be used for application of PAM:

- PAM shall be used as a replacement for other BMPs.
- Do not use PAM on a slope that flows directly into a stream or wetland. All stormwater runoff shall pass through a sediment control BMP prior to discharging to surface waters such as ponds, creeks, streams, and rivers.
- Do not add PAM to water discharging from site.
- When the total drainage area is greater than or equal to 5 acres, PAM-treated areas shall drain to a sediment pond.
- Areas less than 5 acres in size shall drain to sediment control BMPs, such as minimum of 3 check dams per acre. The total number of check dams used shall be maximized to achieve the greatest amount of settlement of sediment prior to discharging from the site. Each check dam shall be spaced evenly in the drainage channel through which stormwater flows are discharged off-site.
- On all sites, the use of perimeter sediment controls shall be maximized to limit the discharges of sediment from the site.
- All areas not being actively worked shall be covered and protected from rainfall.
- PAM can be applied to wet soil, but dry soil is preferred due to less sediment loss.
- Keep the granular PAM supply out of the sun. Granular PAM loses its effectiveness in 3 months after exposure to sunlight and air.
- Proper application and re-application plans are necessary to ensure total effectiveness of PAM usage.
- PAM, when combined with water, is extremely slippery and can be a safety hazard. Care must be taken to prevent spills of PAM powder onto paved surfaces. During an application of PAM, prevent over-spray from reaching pavement as pavement then will become slippery. If PAM powder gets on skin or clothing, wipe it off with a dry, rough towel rather than attempting to wash off with water as the moisture will make clean-up messier and take longer.
- Some PAMs are more toxic and carcinogenic than others. Only the most environmentally safe PAM products should be used.

The specific PAM copolymer formulation must be anionic. **Cationic PAM shall not be used in any application because of known aquatic toxicity problems.** Only the highest drinking-water-grade PAM, certified for compliance with ANSI/NSF Standard 60 for drinking water treatment, will be used for soil applications. Recent media attention and high interest in PAM has resulted in some entrepreneurial exploitation of the term “polymer.” All PAM are polymers, but not all polymers are PAM. And not all PAM products comply with ANSI/NSF Standard 60. If PAM use is called for on a project, its use shall be reviewed and approved by the local permitting authority before application to the site.

- PAM designated for these uses should be “water-soluble” or “linear” or “non-cross-linked.” Cross-linked or water absorbent PAM, polymerized in highly acidic (pH smaller than 2) conditions, are used to maintain soil moisture content.

- The PAM anionic charge density may vary from 2%-30%; a value of 18% is typical. Studies conducted by the United States Department of Agriculture (USDA)/ARS demonstrated that soil stabilization was optimized by using very high molecular weight (12-15 mg/mole), highly anionic (over 20% hydrolysis) PAM.
- PAM tackifiers are available and being used in place of guar and alpha plantago. Typically, PAM tackifiers should be used at a rate of no more than 0.5-1 lb. per 1000 gallons of water in a hydro-mulch machine. Some tackifier product instructions say to use at a rate of 3 to 5 pounds per acre, which can be too much. In addition, pump problems can occur at higher rates due to increased viscosity.

Maintenance Standards

- PAM may be reapplied on actively worked areas after a 48-hour period.
- Re-application is not required unless PAM-treated soil is disturbed or unless turbidity levels show the need for an additional application.
- If PAM-treated soil is left undisturbed a reapplication may be necessary after 2 months. More PAM applications may be required for steep slopes, silty and clayey soils (USDA Class Type "C" and "D" soils), long grades, and high precipitation areas. When PAM is applied first to bare soil and then covered with straw, a re-application may not be necessary for several months.
- Loss of sediment and PAM may be a basis for penalties.
- Requires inspection after each rainfall event to determine if re-application is needed.
- Over-application can create or increase runoff due to reduced infiltration.

BMP 260: Surface Roughening

Purpose

Surface roughening aids in the establishment of vegetative cover, reduces runoff velocity, increases infiltration, and provides for sediment trapping through the provision of a rough soil surface.

Perpendicular depressions to the slope should be created by operating a tiller or other suitable equipment on the contour or by leaving slopes in a roughened condition.

Conditions for Use

- All slopes steeper than 3:1 and greater than 5'-0" vertical should be roughened to a depth of 2" to 4" prior to seeding.
- Areas that will not be stabilized immediately may be roughened to reduce runoff velocity until seeding takes place.
- Slopes with a stable rock face do not require roughening.
- Slopes where mowing is planned should not be excessively roughened.

Design and Installation Specifications

There are different methods for achieving a roughened soil surface on a slope, and the selection of an appropriate method depends upon the type of slope. Roughening methods include stair-step grading, gradient terracing (BMP 261), grooving, contour furrows, and tracking. See the figure on the next page for tracking and contour furrows.

Factors to be considered in choosing a method are slope steepness, mowing requirements, and whether the slope is formed by cutting or filling.

- Disturbed areas that will not require mowing may be stair-step graded, grooved, or left rough after filling.
- Stair-step grading is particularly appropriate in soils containing large amounts of soft rock. Each "step" catches material that sloughs from above, and provides a level site where vegetation can

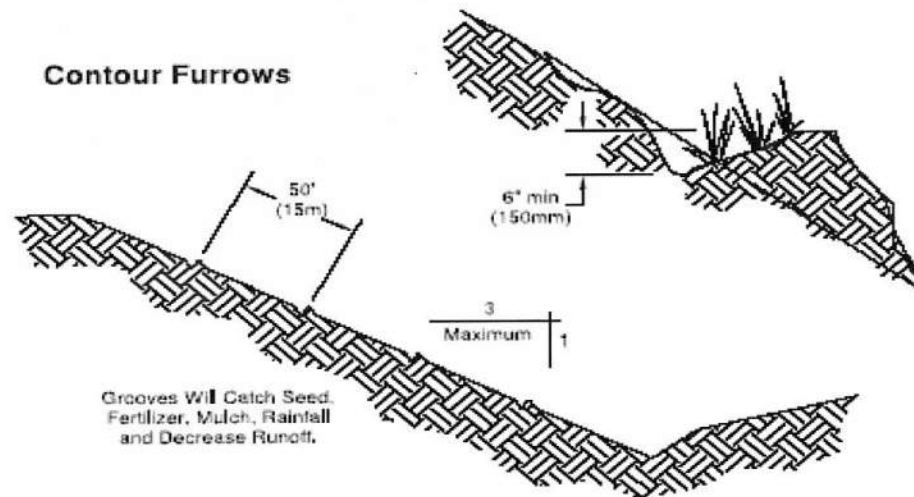
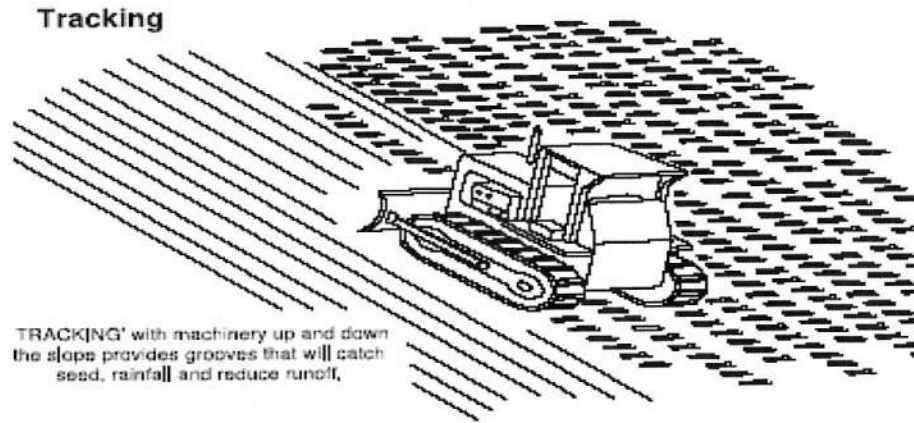

become established. Stairs should be wide enough to work with standard earth moving equipment. Stair-steps must be on contour or gullies will form on the slope. Steps should be wider than the vertical cut and their slope should lay back towards the vertical cut.

- Areas that will be mowed (these areas should have slopes less steep than 3:1) may have small furrows left by disking, harrowing, raking, or seed-planting machinery operated on the contour.
- Graded areas with slopes larger than 3:1 but smaller than 2:1 should be roughened before seeding. This can be accomplished in a variety of ways, including "track walking," or driving a crawler tractor up and down the slope, leaving a pattern of cleat imprints parallel to slope contours.
- Tracking is done by operating equipment up and down the slope to leave horizontal depressions in the soil.
- Grooving can be accomplished using a plow with furrows 3" deep and less than 15" apart.
- Surface roughening should NOT be done with soils with high clay contents.
- All disturbed areas on slopes should be immediately seeded, sodded, mulched, and/or chemically-stabilized once all work has been completed.

Maintenance Standards

- Areas that are graded in this manner should be seeded as quickly as possible.
- Inspections should be made of the area after each rain event until the site is stabilized. If rills appear, they should be re-constructed, re-graded and re-seeded immediately.

BMP 261: Gradient Terraces

Purpose

Gradient terraces reduce erosion damage by intercepting surface runoff and conducting it to a stable outlet at a non-erosive velocity.

Conditions of Use

Gradient terraces normally are limited to denuded land having a water erosion problem. They should not be constructed on deep sands or on soils that are too stony, steep, or shallow to permit practical and economical installation and maintenance. Gradient terraces may be used only where suitable outlets are or will be made available. See the figure on the right for an example of gradient terraces.

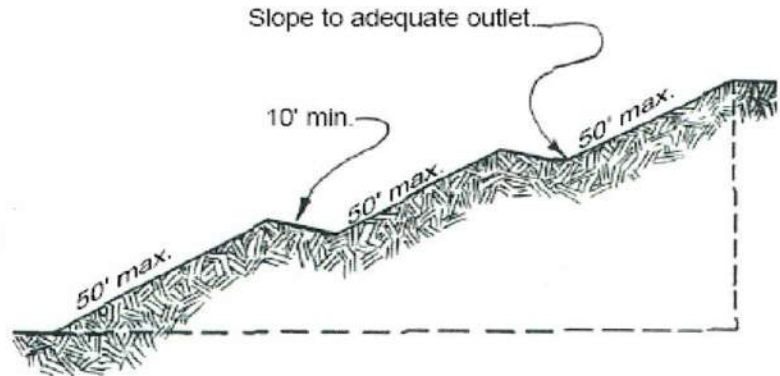

Design and Installation Specifications

- The maximum spacing of gradient terraces should be determined by the following method where:
VI = 0.8s

VI = vertical interval in feet

s = land rise per 100'-0", expressed in feet

- The top of the constructed ridge should not be lower at any point than the design elevation plus the specified overfill for settlement. The opening at the outlet end of the terrace should have a cross section equal to that specified for the terrace channel.
- Channel grades may be either uniform or variable with a maximum grade of 7.5" per 100'-0" length. For short distances, terrace grades may be increased to improve alignment. The channel velocity should not exceed that which is non-erosive for the soil type with the planned treatment.
- All gradient terraces should have adequate outlets. Such an outlet may be a grassed waterway, vegetated area, or tile outlet.
- In all cases the outlet must convey runoff from the terrace or terrace system to a point where the outflow will not cause damage. Vegetative cover should be used in the outlet channel.
- The design elevation of the water surface of the terrace should not be lower than the design elevation of the water surface in the outlet at their junction, when both are operating at design flow.
- Vertical spacing determined by the above methods may be increased as much as 6" or 10%, whichever is greater, to provide better alignment or location, to avoid obstacles, to adjust for equipment size, or to reach a satisfactory outlet.
- The drainage area above the top should not exceed the area that would be drained by a terrace with normal spacing.
- The terrace should have enough capacity to handle the peak runoff expected from a 2-year, 24-hour design storm without overtopping.
- The terrace cross-section should be proportional to the land slope. The ridge height should include a reasonable settlement factor. The ridge should have a minimum top width of 36" at the design height. The minimum cross-sectional area of the terrace channel should be 8 square feet for land slopes flatter than 5%; 7 square feet for slopes from 5% to 8%; and 6 square feet for slopes steeper than 8%. The terrace should be wide enough for be maintenance using a small dozer.

Maintenance Standards

- Maintenance should be performed as needed.
- Terraces should be inspected regularly: at least once a year, and after large storm events.

Chapter 3: Conveyance BMPs

BMP 301: Interceptor Dike and Swale

Purpose

Provide a ridge of compacted soil, or a ridge with an upslope swale, at the top or base of a disturbed slope or along the perimeter of a disturbed construction area to convey stormwater. Use the dike and/or swale to intercept the runoff from unprotected areas and direct it to areas where erosion can be controlled. This can prevent storm runoff from entering the work area or sediment-laden runoff from leaving the construction site.

Conditions of Use

- Locate upslope of a construction site to prevent runoff from entering disturbed area.
- Locate where the runoff from the site or disturbed slope can be safely conveyed to an erosion control facility.
- When placed horizontally across a disturbed slope, it reduces the amount and velocity of runoff flowing down the slope.
- Locate downslope to collect runoff from a disturbed area and direct it to a sediment basin.

Design and Installation Specifications

- Dike and/or swale and channel must be stabilized with temporary or permanent vegetation or other channel protection during construction.
- Channel requires a positive grade for drainage; steeper grades require channel protection and check dams.
- Can be used at top of new fill before vegetation is established.
- May be used as a permanent diversion channel to carry the runoff.
- Sub-basin tributary area should be one acre or less.
- Design capacity for the peak flow from a 10-year, 24-hour design storm for temporary facilities. For facilities that will also serve on a permanent basis, consult the local government's drainage requirements.
- The maximum velocity should not exceed 5 fps.

Table 7: Interceptor Dike Criteria

Top Width: 2'-0" minimum		
Height: 18" minimum on berm		
Side Slope: 2:1 for temporary dikes; should be flatter for permanent ones		
Grade: Depends on topography; system minimum is 0.5% and maximum is 1%		
Compaction: min. 90% ASTM D698 standard proctor		
Horizontal Spacing of Interceptor Dikes:		
Average Slope	% Slope	Length of Flow
less than 20:1	3% - 5%	300 feet
10 to 20:1	5% -10%	200 feet
4 to 10:1	10% -25%	100 feet
2 to 4:1	25% -50%	50 feet

Stabilization: Depends on velocity and reach

Slopes flatter than 5%: Seed and mulch applied within 5 days (see BMP 221, Mulching).

Slopes 5% - 40%: Dependent on runoff velocities and dike materials; **stabilization should be done immediately using sod, native stone, or other measures to avoid erosion.**

Table 8: Interceptor swale criteria

Bottom Width: 24" minimum; the bottom shall be level
 Depth: 12" minimum
 Side Slope: 2:1 for temporary dikes; should be flatter for permanent ones
 Grade Maximum: 5%, with positive drainage to a suitable outlet (such as a sediment pond)
 Stabilization: Seed as per BMP 220 (Temporary and Permanent Seeding) or BMP 302 (Channel Lining); 12" thick stone pressed into the bank and extending at least 8" vertical from the bottom

Maintenance Standards

- Inspect diversion dikes and interceptor swales per the site SWPPP. Immediately remove sediment from the flow area.
- Damage caused by construction traffic or other activity must be repaired before the end of each working day.
- Check outlets and make timely repairs as needed to avoid rill and/or gully formation. When the area below the temporary diversion dike is permanently stabilized, remove the dike and fill and stabilize the channel to blend with the natural surface.
- The upslope side of the dike shall provide positive drainage to the dike outlet. No erosion shall occur at the outlet. Provide energy dissipation measures as necessary. Sediment-laden runoff must be released through a sediment trapping facility.
- Minimize construction traffic over temporary dikes. Use temporary cross culverts for channel crossing.
- Excessive flow rates can cause scour so they should discharge into a sediment-treatment facility.
- Energy dissipaters may be required above and/or below the outfall.

BMP 302: Grass-Lined Channels***Purpose***

Provide a channel with a vegetative lining for conveyance of runoff. See the figures on the next page for typical grass-lined channel cross-sections.

Conditions of Use

This practice applies to construction sites where concentrated runoff needs to be contained to prevent erosion or flooding.

- Vegetative lining can provide sufficient stability for the channel cross section and at lower velocities of water (normally dependent on grade). This means that the channel slopes are generally flatter than 5% and space is available for a relatively large cross section.
- Typical uses include roadside ditches, channels at property boundaries, outlets for diversions, and other channels and drainage ditches in low areas.
- Channels that will be vegetated should be installed before major earthwork and hydro-seeded with a BFM. The vegetation should be well established (i.e., over 75% cover) before water is allowed to flow in the ditch. With channels that will have high flows, erosion control blankets should be installed over the hydro-seed. If vegetation cannot be established from seed before water is allowed in the ditch, sod should be installed in the bottom of the ditch in lieu of hydro-mulch and blankets.

Design and Installation Specifications

- Locate the channel where it can conform to the topography and other features such as roads.
- Locate them to use natural drainage systems to the greatest extent possible.
- Avoid sharp changes in alignment or bends and changes in grade.

- Do not reshape the landscape to fit the drainage channel.
- Design velocities exceeding 2 fps require temporary blankets, mats, or similar liners to protect seed and soil until vegetation becomes established.

Typical V-Shaped Channel Cross-section

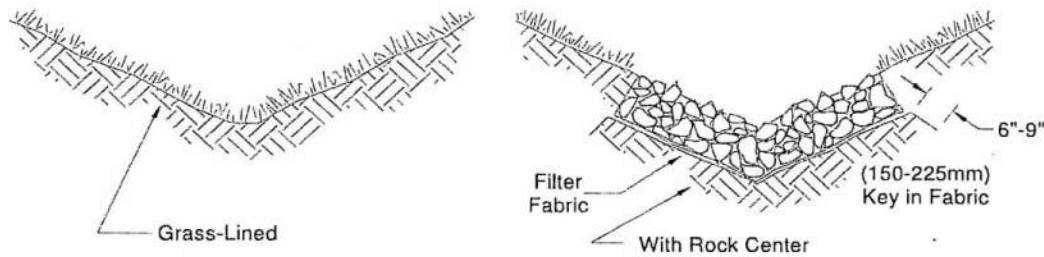

Typical Parabolic Channel Cross-Section

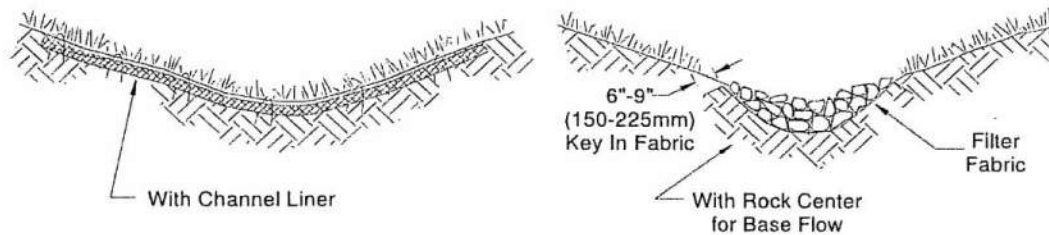

Typical Trapezoidal Channel Cross-Section

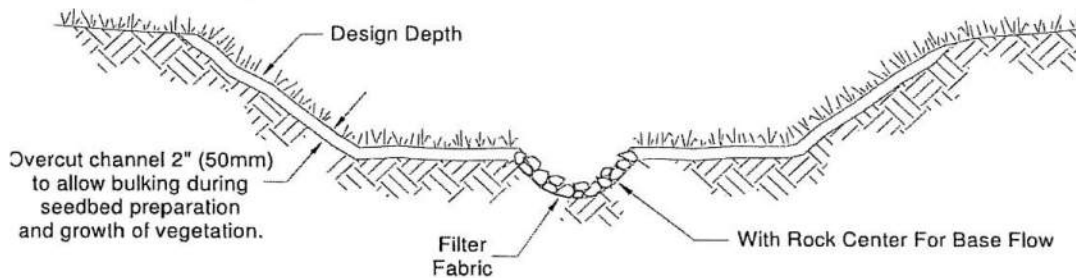

- The maximum design velocity shall be based on soil conditions, type of vegetation, and method of re-vegetation, but at no times shall velocity exceed 5 fps without additional reinforcing of the channel bottom. The channel shall not be overtopped by the peak runoff from a 10-year, 24-hour design storm.
- Where the grass-lined channel will also function as a permanent stormwater conveyance facility, consult the drainage conveyance requirements of the local jurisdiction.
- An **established** grass or vegetated lining is required before the channel can be used to convey stormwater, unless stabilized with nets and/or blankets.
- If design velocity of a channel to be vegetated by seeding is higher than 2 fps, a temporary channel liner is required. Geo-textile or special mulch protection such as fiberglass, straw, and/or netting provides stability until the vegetation is fully established. See the figure on the next page.

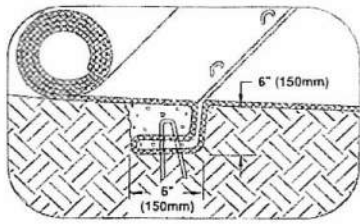
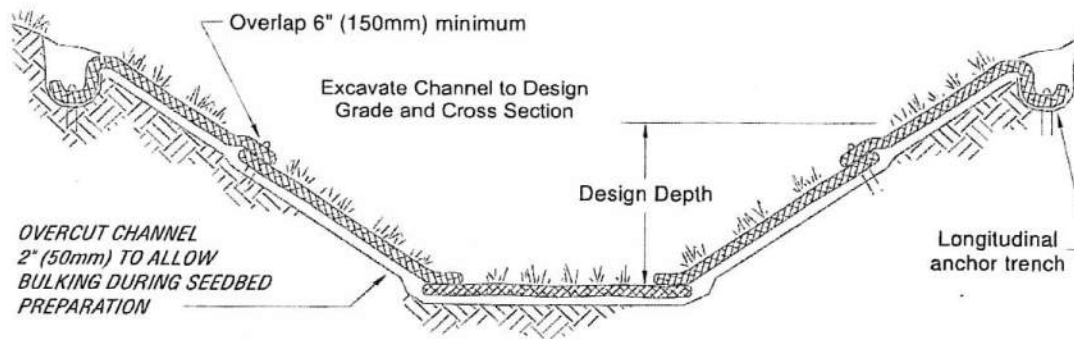

Intermittent Check Slot

TYPICAL INSTALLATION WITH EROSION CONTROL BLANKETS OR TURF REINFORCEMENT MATS

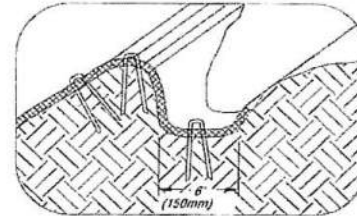

Longitudinal Anchor Trench

Shingle-lap spliced ends or begin new roll in an intermittent check slot

Prepare soil and apply seed before installing blankets, mats or other temporary channel liner system

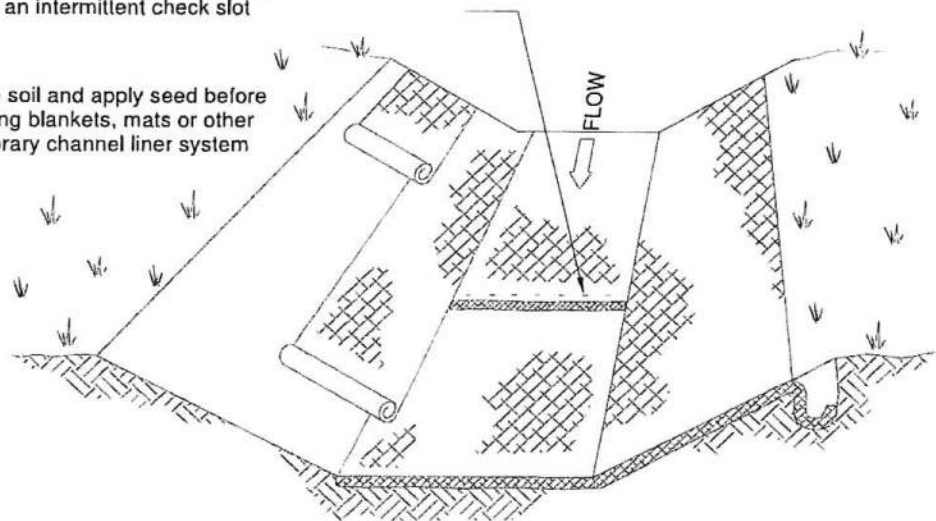

- Check dams shall be removed when the grass has matured sufficiently to protect the ditch or swale, unless the slope of the swale is over 4%. The area beneath the check dams shall be seeded and mulched immediately after dam removal.
- Watering may be required.
- If vegetation is established by sodding, the permissible velocity for established vegetation must be used so that no temporary liner is required.
- Do not subject grass-lined channel to sedimentation from disturbed areas. Use sediment-trapping BMPs upstream of the channel.
- Subsurface drainage or stone channel bottoms, if allowed, may be necessary on sites that are subject to prolonged wet conditions due to long duration flows or a high water table.
- Provide outlet protection at culvert ends and at channel intersections.
- Grass channels, at a minimum, should carry peak runoff for temporary construction drainage facilities from the 10-year, 24-hour storm without eroding. Where flood hazard exists, increase the capacity according to the potential damage.
- Grassed channel side slopes generally are constructed 3:1 or flatter to aid in the establishment of vegetation and for maintenance. Consult local drainage requirements or development codes for

permanent channels.

- Construct channels a minimum of 2" larger around the periphery to allow for soil bulking during seedbed preparations and sod buildup.

V-shaped grass channels generally apply where the quantity of water is small, such as in short reaches along roadsides. The V-shaped cross section is least desirable because it is difficult to stabilize the bottom where velocities may be high.

Trapezoidal grass channels are used where runoff volumes are large and slope is low so that velocities are non-erosive to vegetated linings. (**Note:** It is difficult to construct small parabolic shaped channels.)

Maintenance Standards

During the establishment period, check grass-lined channels after every rainfall.

- After grass is established, periodically check the channel; check it after every heavy rainfall event or construction site SWP3 requirements. Immediately make repairs.
- It is particularly important to check the channel outlet and all road crossings for bank stability and evidence of piping or scour holes.
- Remove all significant sediment accumulations to maintain the designed carrying capacity. Keep the grass in a healthy, vigorous condition at all times, since it is the primary erosion protection for the channel.

BMP 303: Reinforced Channel Lining

Purpose

To protect erodible channels by providing a channel liner using either blankets or stone.

Conditions of Use

When natural soils or vegetated stabilized soils in a channel are not adequate to prevent channel erosion.

- When a permanent ditch or pipe system is to be installed and a temporary measure is needed.
- In almost all cases, synthetic and organic coconut blankets are more effective than native stone for protecting channels from erosion. Blankets can be used with and without vegetation. Blanketed channels can be designed to handle any expected flow and longevity requirement. Some synthetic blankets have a predicted life span of 50 years or more, even in sunlight.
- Other reasons why blankets are better than stone include the availability of blankets over rock. In many areas, rock may not be easily obtainable, is very expensive to haul to a site, and/or may be prohibited to use by local ordinance. Blankets can be delivered anywhere. Rock requires the use of heavy equipment to haul and place. Blankets usually only require laborers with hand tools, and sometimes a backhoe.
- The Federal Highway Administration (FHA) recommends not using flexible liners whenever the slope is above 10%, or the shear stress is greater than 8 psf.

Design and Installation Specifications

See BMP 222 for information on nets and blankets. Since stone is used where erosion potential is high, construction must be sequenced so that the stone is put in place with the minimum possible delay.

- Disturbance of areas where the stone is to be placed should be undertaken only when final preparation and placement of the stone can follow immediately behind the initial disturbance. Where stone is used for outlet protection, it should be placed before or in conjunction with the construction of the pipe or channel so that it is in place when the pipe or channel begins to operate.
- The designer, after determining the stone size that will be stable under the flow conditions, shall consider that size to be a **minimum** size and then, based on gradations available in the area, select the size(s) that equal or exceed the minimum size. The possibility of drainage structure damage by

children shall be considered in selecting a stone size, especially if there is nearby water or a gully in which to toss the stones.

- Stone shall consist of field stone or quarry stone of approximately rectangular shape. The stone shall be hard and angular and of such quality that it will not disintegrate on exposure to water or weathering and it shall be suitable in all respects for the purpose intended.
- Rubble concrete may be used provided it has a density of at least 150 pcf and otherwise meets the requirement of this standard and specification.
- A lining of engineering filter fabric (geo-textile) shall be placed between the stone and the underlying soil surface to prevent soil movement into or through the stone. The geo-textile should be keyed in at the top of the bank.
- Filter fabric shall not be used on slopes greater than 3:2 as slippage may occur. It should be used in conjunction with a layer of coarse aggregate (granular filter blanket) when the stone to be placed is 12" and larger.

Maintenance Standards

BMP 304: Vegetated Strip

Purpose

Vegetated strips reduce the transport of coarse sediment from a construction site by providing a temporary physical barrier to sediment and reducing the runoff velocities of overland flow.

Conditions of Use

- Vegetated strips may be used downslope of all disturbed areas.
- Vegetated strips are not intended to treat concentrated flows, nor are they intended to treat substantial amounts of overland flow. Any concentrated flows must be conveyed through the drainage system to a sediment pond. The only circumstances in which overland flow can be treated solely by a strip, rather than by a sediment pond, is when the criteria in the following table are met, or municipal specifications, whichever is more restrictive.

Table 9: Vegetated Strip

Average Slope	% Slope	Length of Flow
3:2 or less	less than 67%	100 feet
2:1 or less	less than 50%	115 feet
4:1 or less	less than 25%	150 feet
6:1 or less	less than 16%	200 feet
10:1 or less	less than 10%	250 feet

Design and Installation Specifications

- The vegetated strip shall consist of a minimum of a 25'-0" wide continuous strip of dense vegetation with permeable topsoil. Grass covered, landscaped areas are generally not adequate because the volume of sediment overwhelms the grass. Ideally, vegetated strips shall consist of undisturbed native growth with a well-developed soil that allows for infiltration of runoff.
- The slope within the strip shall not exceed 4:1.
- The uphill boundary of the vegetated strip shall be delineated with clearing limits.

Maintenance Standards

- Any areas damaged by erosion or construction activity shall be seeded immediately and protected by mulch.

- If more than 5'-0" of the original vegetated strip width has had vegetation removed or is being eroded, sod must be installed.
- If there are indications that concentrated flows are traveling across the buffer, surface water controls must be installed to reduce the flows entering the buffer, or additional perimeter protection must be installed.

BMP 310: Diversionary Ditch

Purpose

A small ditch or ridge of material is constructed diagonally across a road or right-of-way to divert stormwater runoff from the road surface, wheel tracks, or a shallow road ditch.

Conditions of use

Clearing right-of-way and construction of access for power lines, pipelines, and other similar installations often require long narrow right-of-ways over sloping terrain. Disturbance and compaction promotes gully formation in these cleared strips by increasing the volume and velocity of runoff. Gully formation may be especially severe in tire tracks and ruts. To prevent the formation of rills and gullies, runoff can often be diverted across the width of the right-of-way to undisturbed areas by using small pre-designed diversions.

Give special consideration to each individual outlet area, as well as to the cumulative effect of added diversions. Use gravel to stabilize the diversion where significant vehicular traffic is anticipated.

Design and Installation Specifications

- Height: 8" minimum measured from the channel bottom to the ridge top
- Side slope of channel: 2:1 maximum; 3:1 or flatter when vehicles will cross.
- Base width of ridge: 6" minimum.
- Locate to use natural drainage systems and to discharge into stable, well-vegetated areas.

Table 10: Diversionary Ditch Spacing Guidelines

% Slope	Spacing
Less than 5%	125 feet
5% to 10%	100 feet
10% to 20%	75 feet
20% to 35%	50 feet
More than 35%	use rock lining

- Grade and angle: Select angle that results in ditch slope less than 2%.
- Install as soon as the clearing and grading is complete. Reconstruct when construction is complete on a section when utilities are being installed.
- Compact the ridge when installed.
- Stabilize; seed; and mulch the portions that are not subject to traffic. Gravel the areas crossed by vehicles.

Maintenance Standards

- Periodically inspect right-of-way diversions for wear and after every heavy rainfall for erosion damage.
- Immediately remove sediment from the flow area and repair the dike.
- Check outlet areas and make timely repairs as needed.
- When permanent road drainage is established and the area above the temporary right-of-way

diversion is permanently stabilized, remove the dike and fill the channel to blend with the natural ground, and appropriately stabilize the disturbed area.

BMP 311: Pipe-Slope Drains

Purpose

To convey stormwater any time water needs to be diverted away from or over bare soil to prevent gullies, channel erosion, saturation of slide-prone soils, or the creation of concentrated flows.

Conditions of Use

Pipe-slope drains can be open or closed conduits used as a temporary or permanent stormwater conveyance to move the water down a steep slope to protect the slope from erosion. See the figure below.

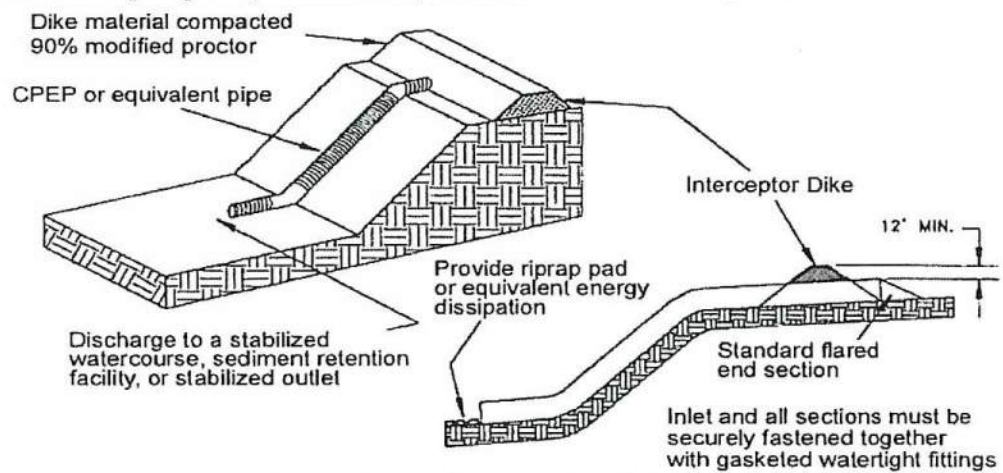

On highway projects, they should be used at bridge ends to collect runoff and pipe it to the base of the fill slopes along bridge approaches. These can be designed into a project and included as bid items. Another use on road projects is to collect runoff from pavement and pipe it away from side slopes. These are useful because there is generally a time lag between having the first lift of asphalt installed and the curbs, gutters, and permanent drainage installed. Used in conjunction with sand bags, or other temporary diversion devices, these will prevent massive amounts of sediment from leaving a project.

Water can be collected; channeled with: sand bags, Geo-textile Encased Check Dams (BMP 308), berms, or other material; and/or piped to temporary sediment ponds.

Pipe-slope drains can be:

- Connected to new catch basins and used temporarily until all permanent piping is installed;
- Used to drain water collected from aquifers exposed on cut slopes and take it to the base of the slope;
- Used to collect clean runoff from plastic sheeting and direct it away from exposed soil;
- Installed in conjunction with BMP 351 (Reinforced Perimeter Sediment Barrier) to drain collected water to a controlled area;
- Used to divert small seasonal streams away from construction. They have been used successfully on culvert replacement and extension jobs. Large flex pipe can be used on larger streams during culvert removal, repair, or replacement; and,
- Connected to existing down spouts and roof drains and used to divert water away from work areas during building renovation, demolition, and construction projects. There are now several commercially available collectors that are attached to the pipe inlet and help prevent erosion at the inlet.

Design and Installation Specifications

Size to convey the design flow. The capacity for temporary drains shall be sufficient to handle the peak flow from a 10-year, 24-hour design storm event. Consult local drainage requirements for sizing permanent pipe-slope drains.

- Water should be collected from an area smaller than 5 acres in size.
- Most jurisdictions have a minimum pipe size requirement.
- Open conveyances should have higher sides to ensure that all flows are contained.
- Energy dissipaters may be required before the outfall.
- Use care in clearing vegetated slopes for installation.
- Re-establish cover immediately on areas disturbed by installation.
- Use temporary drains on new cut or fill slopes.
- Use diversion dikes or swales to collect water at the top of the slope. Ensure that the inlet area is stable and large enough to direct flow into the pipe.
- Piping of water through the berm at the site's entrance area is a common failure mode.
- The inlet side shall consist of a standard flared end section for culverts 12" and larger with a minimum 6" metal toe plate to prevent runoff from undercutting the pipe inlet. The slope of the entrance shall be steeper than 3%. Sand bags may also be used at pipe inlets as a temporary measure.
- The soil around and under the pipe and entrance section shall be thoroughly compacted to prevent undercutting.
- The flared inlet sections should be securely connected to the slope drain with watertight connecting bands.
- Slope drain sections should be securely fastened together, fused or have gasketed watertight fittings, and be anchored into the soil.
- Thrust blocks should be installed at each 90-degree pipe bends are utilized. Depending on size of pipe and flow, these can be constructed with sand bags, straw bales staked in place, T-posts and wire, or ecology blocks.
- Pipes need to be secured along their length to prevent movement every 10 to 20 feet of pipe length, depending on the size of the pipe and quantity of water to be diverted. Anchoring can be done with steel T-posts and wire by installed a post on each side of the pipe and then wiring the pipe to them.
- Interceptor dikes shall be used to direct runoff into a slope drain. The height of the dike shall be at least 12" higher at all points than the top of the inlet pipe.
- The area below the outlet must be stabilized (see BMP 340 Outlet Protection) with a stone apron or other appropriate outlet material.
- If the pipe-slope drain conveys sediment-laden water, all flows needs to be directed into a sediment-trapping facility or device.
- Material specifications for many pipe systems are set by the local jurisdiction.
- Incorrect construction may lead to the gullies, rills, erosion, scour, and/or the failure of other downstream devices.

Maintenance Standards

Check inlet and outlet points regularly, especially after storms.

- The inlet should be free from undercutting, and no water should be going around the point of entry. If there are problems, a headwall may need to be constructed or shall be reinforced with compacted earth or sand bags.
- The outlet point should be free from erosion and installed with appropriate outlet protection (i.e. energy dissipater and/or scour prevention).
- For permanent installations, inspect the pipe periodically for vandalism and physical distress such as slides and wind-throw.
- Normally the pipe slope is so steep that clogging is not a problem with a smooth-wall pipe; however, trash and/or debris may become lodged in the pipe.

BMP 312: Subsurface Drains

Purpose

To intercept, collect, and convey ground water to a satisfactory outlet, using a perforated pipe or conduit below the ground surface. Subsurface drains are also known as French drains. The perforated pipe provides a dewatering mechanism to drain excessively wet soils, provide a stable base for construction, improve stability of structures with shallow foundations, and/or to reduce hydrostatic pressure to improve slope stability.

Conditions of Use

Use when excessive water must be removed from the soil. The permeability of the soil as well as the depth to water table and impervious layers are all factors which govern the use of subsurface drains.

This standard does not apply to subsurface drains for building foundations or deep excavations.

Design and Installation Specifications

Relief drains are used either to lower the water table in large, relatively flat areas; improve the growth of vegetation; and/or to remove surface water. They are installed along a slope and drain in the direction of the slope. They can be installed in a grid pattern; a herringbone pattern; or a random pattern.

Interceptor drains are used to remove excess groundwater from a slope; stabilize steep slopes; and/or lower the water table immediately below a slope to prevent the soil from becoming saturated. They are installed perpendicular to a slope and drain to the side of the slope. They usually consist of a single pipe or series of single pipes instead of a patterned layout.

- The **depth and spacing of an interceptor drain** is determined primarily by the depth to which the water table is to be lowered or the depth to a confining layer. For practical reasons, the maximum depth is usually limited to 6'-0", with a minimum cover of 24" to protect the conduit.
- The soil should have depth and sufficient permeability to permit installation of an effective drainage system at a depth of 24" to 6'-0".
- An adequate outlet for the drainage system must be available either by gravity or by pumping.
- The quantity and quality of discharge needs to be accounted for in the receiving stream (additional detention may be required).
- The capacity of an interceptor drain is determined by calculating the maximum rate of ground water flow to be intercepted. Therefore, it is good practice to make complete subsurface investigations, including hydraulic conductivity of the soil, before designing a subsurface drainage system.
- **Subsurface drains should be sized** to carry the required capacity without pressure flow. Minimum diameter for a subsurface drain is 4".
- The minimum velocity required to prevent silting is 1.4 fps. The line shall be graded to achieve this velocity at a minimum. The maximum allowable velocity using a sand-gravel filter or envelope is 9 fps.
- Filter material and fabric shall be used around all drains for proper bedding and filtration of fine materials. Envelopes and filters should surround the drain to a minimum of 3" thickness.
- The outlet of the subsurface drain shall empty into a sediment pond through a catch basin. If free of sediment, it can then empty into a receiving channel, swale, or stable vegetated area adequately protected from erosion and undermining.
- The trench shall be constructed on a continuous grade with no reverse grades or low spots.
- Soft or yielding soils under the drain shall be stabilized with gravel or other suitable material.
- Backfilling shall be done immediately after placement of the pipe. No sections of pipe shall remain uncovered overnight or during a rainstorm. Backfill material shall be placed in the trench in such a manner that the drain pipe is not displaced or damaged. Do not install permanent drains near trees. Avoiding the tree roots will prevent them from expanding towards the line and clogging it. Use solid pipe with watertight connections where it is necessary to pass a subsurface drainage system through a stand of trees (whether existing or to be placed at a later date).

- Ensure that the **outlet** of a drain empties into a channel or other watercourse above the normal water level.
- Secure an animal guard to the outlet end of the pipe to keep out rodents.
- Use outlet pipe of corrugated metal, cast iron, or heavy-duty plastic without perforations and at least 10'-0" long. Do **not** use an envelope or filter material around the outlet pipe. Bury at least two-thirds of the pipe length.
- When outlet velocities exceed those allowable for the receiving stream, outlet protection must be provided.

Maintenance Standards

Subsurface drains shall be checked periodically to ensure that they are free-flowing and not clogged with sediment or roots.

- The outlet shall be kept clean and free of debris.
- Surface inlets shall be kept open and free of sediment and other debris.
- Trees located too close to a subsurface drain often clog the system with their roots. If a drain becomes clogged, relocate the drain or remove the trees as a last resort. Drain placement should be planned to minimize this problem.
- Where drains are crossed by heavy vehicles, the line shall be checked to ensure that it is not crushed.

BMP 313: Level Spreader

Purpose

Level spreaders provide a temporary outlet for dikes and diversions consisting of an excavated depression constructed at 0% grade across a slope, or can convert concentrated runoff to sheet flow and release it onto areas stabilized by existing vegetation or an engineered filter strip.

Conditions of Use

Used when a concentrated flow of water needs to be dispersed over a large area with existing stable vegetation.

- Use only where the slopes are gentle, the water volume is relatively low, and the soil will absorb most of the low flow events.
- Items to consider are:
 1. What is the risk of erosion or damage if the flow may become concentrated?
 2. Is an easement required if discharged to adjoining property?
 3. Most of the flow should be as ground water and not as surface flow.
 4. Is there an unstable area downstream that cannot accept additional ground water?

Design and Installation Specifications

- Use above undisturbed areas that are stabilized by existing vegetation. If the level spreader has any low points, flow will concentrate, create channels and may cause erosion.
- Discharge area below the outlet must be uniform with a slope of less than 5:1.
- Outlet to be constructed level in a stable, undisturbed soil profile (not on fill).
- The runoff shall not be allowed to re-concentrate after release unless intercepted by another downstream measure.
- The grade of the channel for the last 20'-0" of the dike or interceptor entering the level spreader shall be less than 1%. The grade of the level spreader shall be 0% to ensure uniform spreading of storm runoff.
- A 6" high gravel berm placed across the level lip shall consist of washed crushed rock, ¾" to 1½" OR 2" to 4" in size.

- The spreader length shall be determined by estimating the peak flow expected from the 10-year, 24-hour design storm. The length of the spreader shall be a minimum of 15'-0" for 0.1 cfs and shall be an additional 10'-0" for each 0.1 cfs there after to a maximum of 0.5 cfs per spreader. Use multiple spreaders for higher flows.
- The width of the spreader should be at least 6'-0".
- The depth of the spreader as measured from the lip should be at least 6" and uniform across the entire length.
- Level spreaders shall be setback from property lines unless there is an easement for the flow.
- Level spreaders, when installed every so often in grassy swales, keep flows from re-concentrating. Materials that can be used include sand bags, logs, lumber, concrete, and pipes. To function properly, the materials need to be installed level and on-contour. The figure below provides a cross-section of a level spreader.

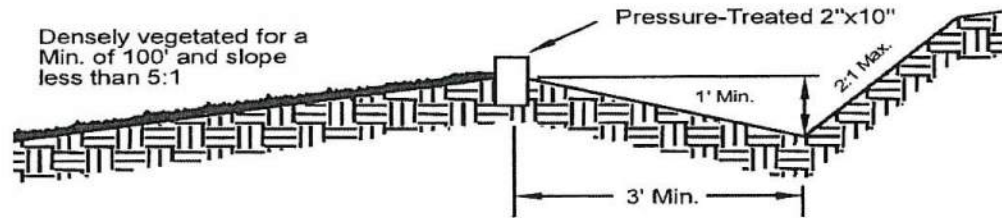

- The figure below provides a detail of a level spreader.

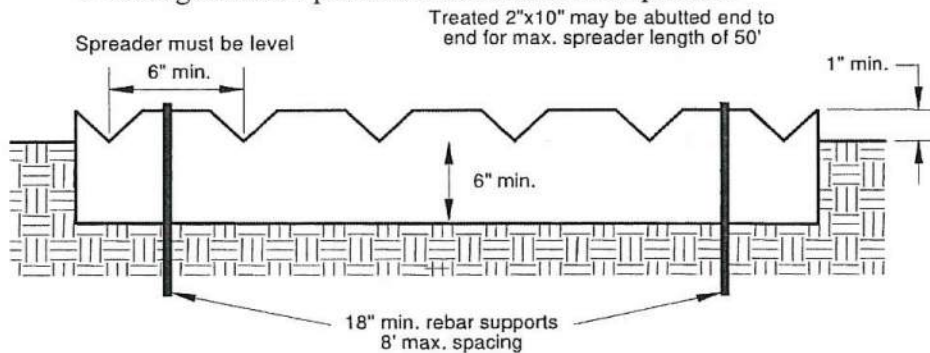

Maintenance Standards

- The spreader should be inspected after every runoff event to ensure that it is functioning correctly.
- The contractor should avoid the placement of any materials on the structure and should prevent construction traffic from crossing the structure.
- If the spreader is damaged by construction traffic, it shall be immediately repaired.

BMP 320: Waddles or Wattles

Purpose

Waddles or wattles are temporary erosion and sediment control barriers consisting of straw or other grain, chipped wood, pulverized rubber bits, or other plant fiber fillers that are wrapped in bio-degradable tubular plastic, geo-textile fabric, or similar encasing material. They reduce the velocity and can spread the flow runoff while capturing and retaining sediment. They are typically 8" to 10" in diameter and 20'-0" to 30'-0" long. The wattles are placed in shallow trenches and staked along the contour of disturbed or newly constructed slopes. See the figure below for typical construction details.

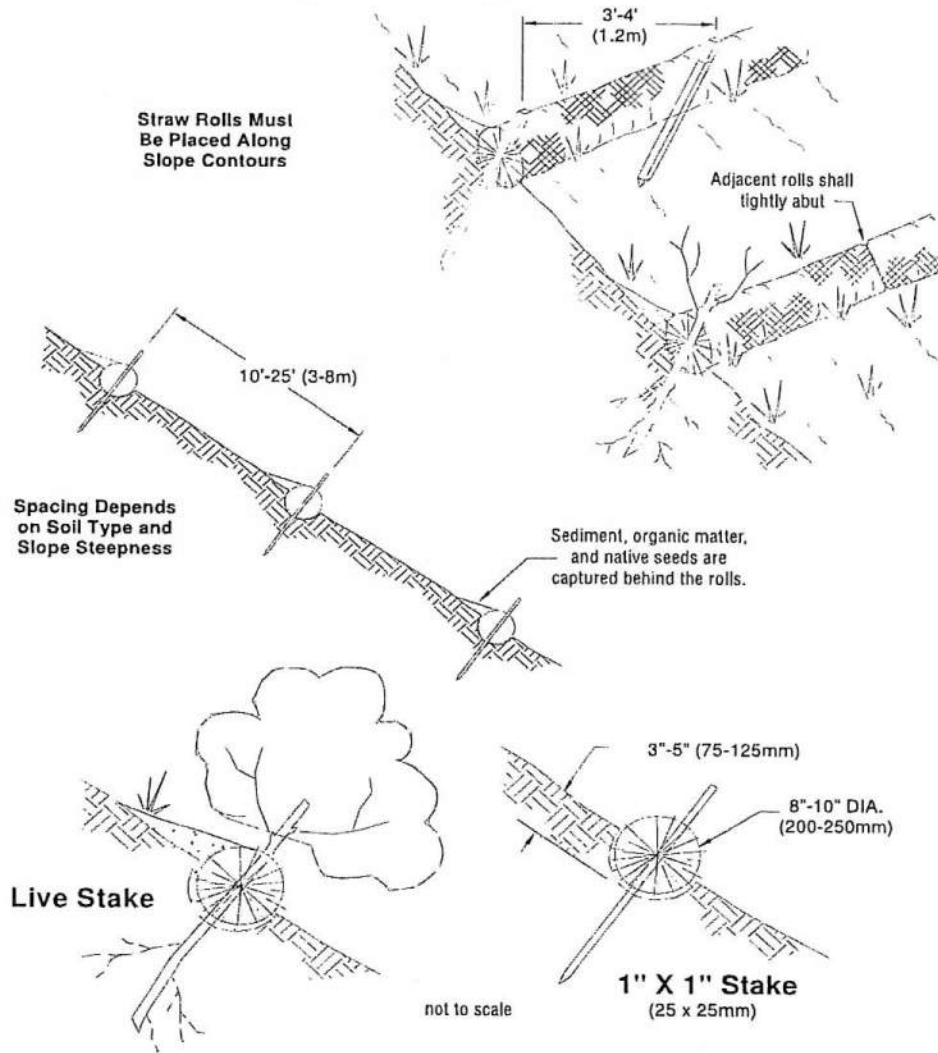

Conditions of Use

- Disturbed areas that require immediate erosion protection.
- Exposed soils during the period of short construction delays, or over winter months.
- On slopes requiring stabilization until permanent vegetation can be established.
- Straw wattles are effective for 1 to 2 seasons.
- If conditions are appropriate, wattles can be staked to the ground using willow cuttings for added re-vegetation.
- Rills and gullies can develop beneath wattles if they are not properly entrenched.
- Water can pass between wattles if not tightly abutted together.

Design and Installation Specifications

- It is critical that wattles are installed perpendicular to the flow direction and parallel to the slope contour.

- Narrow trenches should be dug across the slope on contour to a depth of 3" to 5" on clay soils and soils with gradual slopes. On loose soils; steep slopes; or areas with high rainfall, the trenches should be dug to a depth of 5" to 7", or over 50% of the thickness of the wattle.
- Start building trenches and installing wattles from the base of the slope and work up. Excavated material should be spread evenly along the uphill slope and compacted using hand tamping or other methods.
- Construct trenches at contour intervals of 3'-0" to 30'-0" apart depending on the steepness of the slope, soil type, and rainfall. The steeper the slope the closer together the trenches should be.
- Install the wattles snugly into the trenches and abut tightly end to end. Do not overlap the ends.
- Install stakes at each end of the wattle, and at 4'-0" centers along entire length of wattle.
- If required, install pilot holes for the stakes using a straight bar to drive holes through the wattle and into the soil.
- At a minimum, wooden stakes should be approximately ¾" x ¾" x 24". Willow cuttings or 3/8" rebar can also be used for stakes.

Maintenance Standards

- Stakes should be driven through the middle of the wattle, leaving 2" to 3" of the stake protruding above the wattle.
- Wattles may require maintenance to ensure they are in contact with the ground surface and thoroughly entrenched, especially after significant rainfall on steep, sandy soils.
- Inspect the slope after each significant storm and repair any area where wattles are not tightly abutted together or where water has scoured beneath them.

BMP 321: Check Dams

Purpose

Construction of small dams across a swale or ditch reduces the velocity of concentrated flow and dissipates energy while providing a location for sediment and other items to settle out of the water.

Conditions of Use

Where temporary channels or permanent channels are not yet vegetated; channel lining is unfeasible; and velocity checks are required.

- Check dams may not be placed in permanent- or seasonally-flowing streams unless approved by the U.S. Fish and Wildlife Service (USFWS). Check dams may not be placed in wetlands without approval from all permitting agencies.
- Check dams shall not be placed below the expected backwater from any fish-bearing water between October 1 and May 31 to ensure that there is no loss of high flow refuge habitat for over-wintering juvenile fish.

Design and Installation Specifications

Whatever material is used, the dam should form a triangle when viewed from the side. This prevents undercutting as water flows over the face of the dam rather than falling directly onto the ditch bottom. Check dams with sumps work more effectively at slowing flow and retaining sediment than a check dam alone. A deep sump should be provided immediately upstream of the check dam.

- In some cases, if carefully located and designed, check dams can remain as permanent installations with very minor re-grading. They may be left as either spillways (accumulated sediment should be graded and seeded), or as check dams to prevent further sediment from leaving the site.
- Check dams can be constructed of rock or pea-gravel filled bags. A number of new products are also available for this purpose and tend to be re-usable, quick and easy to install, effective, and cost

efficient.

- Check dams should be placed perpendicular to the flow of water.
- The maximum spacing between the dams shall be such that the toe of the upstream dam is at the same elevation as the top of the downstream dam.
- Keep the maximum height at 24" at the center of the dam.
- Keep the center of the check dam at least 12" lower than the outer edges at natural ground elevation.
- Keep the side slopes of the check dam at 2:1 or flatter. Key the stone into the ditch banks and extend it beyond the abutments a minimum of 18" to avoid washouts from overflow around the dam.
- Use filter fabric under a rock or sand bag check dam. A piece of organic or synthetic blanket cut to fit will also work for this purpose.
- Rock check dams shall be constructed of appropriately-sized rock. The rock must be placed by hand or by mechanical means (no dumping of rock to form dam) to achieve complete coverage of the ditch or swale and to ensure that the center of the dam is lower than the edges. The rock used must be large enough to stay in place given the expected design flow through the channel.
- Scour can occur at the outfall toe if not correctly constructed or maintained.
- In the case of grass-lined ditches and swales, all check dams and accumulated sediment shall be removed when the grass has matured sufficiently to protect the ditch or swale - unless the slope of the swale is above 4%. The area beneath the check dams shall be seeded and mulched immediately after dam removal.
- Ensure that channel appurtenances, such as culvert entrances below check dams, are not subject to damage or blockage from displaced stones.
- This figure depicts a typical rock check dam.

View Looking Upstream

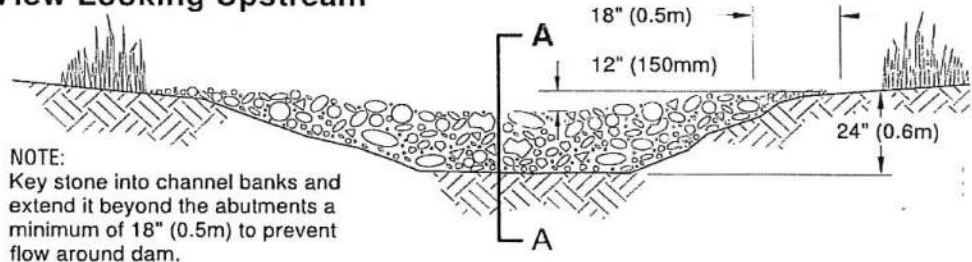

Section A - A

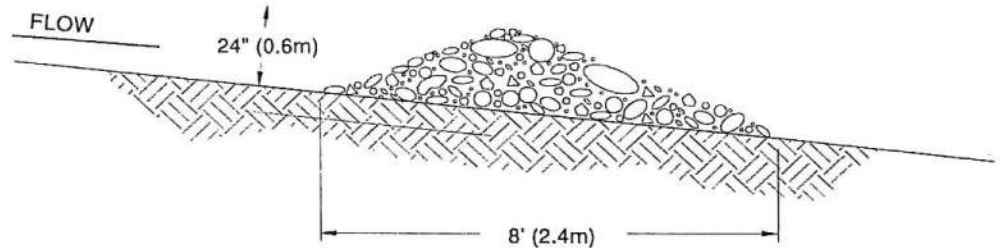

Spacing Between Check Dams

'L' = the distance such that points 'A' and 'B' are of equal elevation.

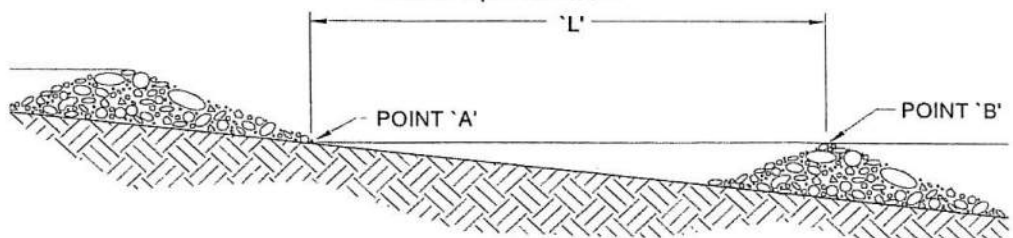

Maintenance Standards

- Check dams shall be inspected weekly and after each runoff event until the upstream area has stabilized. Once stabilization has occur the check dam should be removed unless is to remain as a permanent BMP shown on the plans.
- Permanent dams shall be on stabilized site shall be monitored for performance and sediment accumulation bi-annually and after unusually large storm events to check for stability and needed repairs.
- Sediment shall be removed when it reaches 50% of the sump depth (or height of the dam).
- Inspections should look for missing or dislodged materials. These should be replaced within a timely manner to maintain the dam's shape and function.
- Anticipate submergence and deposition above the check dam and erosion from high flows around the edges of the dam.
- If significant erosion occurs between dams, install a protective stone liner in that portion of the channel.

BMP 322: Geo-Textile Encased Check Dam***Purpose***

Geo-Textile Encased Check Dams may be used as for temporary stockpile protection, perimeter protection, inlet protection, or temporary interceptor dike.

Conditions of use

- May be used in place of other typed of temporary check dams in ditches of any dimension.
- May be used on soil or pavement with adhesive or staples.
- Geo-Textile Encased Check Dams have been used to build temporary:
 - diversion ditches
 - sediment ponds
 - concrete wash-out facilities
 - curbing
 - water bars
 - level spreaders
 - berms

Design and Installation Specifications

Generally made of urethane foam sewn into a woven geo-synthetic fabric. It is often triangular, 10" to 14" high in the center, with a 20" to 28" wide base. A 24" wide apron extends beyond both sides of the triangle along its standard length of about 7'-0". A sleeve at one end allows attachment of additional sections as needed.

- Install with ends curved upstream to prevent water from flowing around the ends.
- The fabric flaps and check dam units are attached to the ground with wire staples. Wire staples should be # 11 gage and 8" to 12" long.
- When multiple units are installed, the sleeve of fabric at the end of each unit shall be wrapped over the abutting unit and be stapled into place before the adjoining units are staked to the ground.
- Check dams should be located and installed as soon as construction will allow.
- Check dams should be placed perpendicular to the flow of water. The leading edge must be secured by burying or with rocks, sandbags, or a small key slot and staples.
- When used in grass-lined ditches and swales, check dams and accumulated sediment shall be removed when the grass has matured sufficiently to protect the ditch or swale unless the slope of the

swale is above 4%. The area beneath the check dams shall be seeded and mulched immediately after dam removal.

Maintenance Standards

- Geo-textile Encased Check Dams shall be monitored for performance and sediment accumulation during and after each runoff event.
- Sediment shall be removed when it reaches 50% of the height of the dam.
- Anticipate submergence and deposition above the dam and erosion from high flows around the edges. Immediately repair any damage or any undercutting of the dam.

BMP 323: Brush Barrier

Purpose

The purpose of brush barriers is to reduce the transport of coarse sediment from a construction site by providing a temporary physical barrier to sediment and reducing the runoff velocities of overland flow.

Conditions of Use

- Brush barriers may be used downslope of all disturbed areas of less than 10,000 square feet.
- Brush barriers are not intended to treat concentrated flows, nor are they intended to treat substantial amounts of overland flow. Any concentrated flows must be conveyed through the drainage system to a sediment pond. The only circumstances in which overland flow can be treated solely by a barrier, rather than a sediment pond, is when the area draining to the barrier is small.
- Brush barriers should only be installed on contours.

Design and Installation Specifications

- Height: 24" (minimum) to 5'-0" (maximum)
- Width: 5'-0" at base (minimum) to 15'-0" (maximum)
- Filter fabric may be anchored over the brush berm to enhance the filtration ability of the barrier. 10-ounce burlap is an adequate alternative for fabric.
- Chipped site vegetation, composted mulch, or wood-based mulch can be used to construct brush barriers.
- There should be no metal, plastic, trash, or other contaminants in the barrier.
- A 100% biodegradable installation can be constructed using 10-ounce burlap held in place by wooden stakes. The figure below depicts a typical brush barrier.

If required, drape filter fabric over brush and secure in 4"x4" min. trench with compacted backfill.

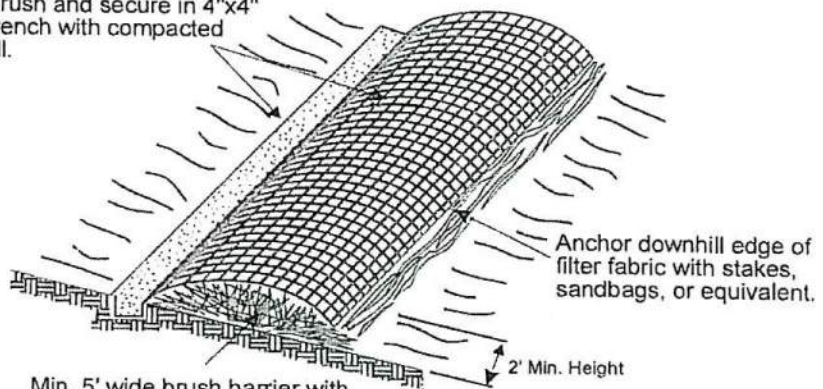

Min. 5' wide brush barrier with max. 6" diameter woody debris. Alternatively topsoil strippings may be used to form the barrier.

Maintenance Standards

- There shall be no signs of erosion or concentrated runoff under or around the barrier. If concentrated flows are bypassing the barrier, it must be expanded or augmented by toed-in filter fabric.
- The dimensions of the barrier must be maintained.

BMP 324: Gravel Filter Berm***Purpose***

A gravel filter berm is constructed on rights-of-way or traffic areas within a construction site to retain sediment by using a filter berm of gravel or crushed rock.

Conditions of Use

Gravel filter berms are used where a temporary measure is needed to retain sediment from entering rights-of-way, in traffic areas, or other paved areas that discharge directly into the drainage system (man-made or natural).

Design and Installation Specifications

- Berm material shall be ¾" to 3" size; washed; well-graded gravel or crushed rock with fewer than 5% fines.
- Spacing of berms:
 - Every 300'-0" on slopes flatter than 5%
 - Every 200'-0" on slopes between 5% and 10%
 - Every 100'-0" on slopes steeper than 10%
- Berm dimensions:
 - 12" high with 3:1 side slopes
 - 8'-0" wide per 1.0 cfs runoff, based on the 10-year, 24-hour design storm
 - Per local, state, or federal regulations, if more restrictive

Maintenance Standards

Regular inspection is required. Sediment shall be removed and filter material replaced as needed.

BMP 330: Storm Drain Inlet Protection***Purpose***

To prevent sediment and other attached pollutants (i.e. oil, grease, trash, debris, herbicides, and pesticides) from entering drainage systems prior to permanent stabilization of the disturbed area.

Conditions of Use

Place where storm drain inlets are to be made operational before permanent stabilization of the disturbed drainage area. Protection should be provided for all storm drain inlets and within 500'-0" downslope of a disturbed or construction area, unless the runoff that enters the catch basin will be conveyed to a sediment pond or trap. Inlet protection may be used anywhere to protect the drainage system. It is likely that the drainage system will still require cleaning.

The table below lists several options for inlet protection. All of the methods for storm drain inlet protection are prone to plugging and require a high frequency of maintenance. Drainage areas should be limited to 1 acre or less. Emergency overflows may be required where stormwater ponding would cause a hazard. If

an emergency overflow is provided, additional beyond-the-end-of-pipe treatment will be required.

Table 11: Storm Drain Inlet Protection

Type of Protection	Emergency Overflow	Paved or Earthen Surfaces	Conditions of use
Drop Inlet Protection			
Excavated	Temporary flooding will occur	Earthen	Applicable for heavy flows; easy to maintain; larger drainage area; requires 30'-0" by 30'-0" per drained acre
Block & Gravel	Yes	Paved or earthen	Applicable for heavy concentrated flows; will NOT pond
Gravel & Wire	No	----	Applicable for heavy concentrated flows; will pond; can withstand traffic
Basin filters	Yes	Paved or earthen	Frequent maintenance required
Curb Inlet Protection			
Wooden weir	Small capacity overflow	Paved	Used for sturdy, more compact installations
Sediment trap	----	Paved or earthen	18 month expected life
J-Hook	Small capacity overflow	Paved	----

Design and Installation Specifications

No protection should create ponding or flooding on adjoining travel way surfaces, such as streets, driveways, and sidewalks. Where existing curb, gutters, driveways, streets, etc. neighbor an inlet protection device, the device should be no taller than the existing curb height to prevent creating a driving hazard.

Excavated Drop Inlet Protection is for an excavated impoundment around a storm drain allowing sediment to settle out of the stormwater before it enters a storm drain.

- Depth 12"-24" as measured from the crest of the inlet structure
- Side slopes no steeper than 2:1
- Minimum volume of excavation: 35 cubic yards
- Shape basin to fit site with longest dimension oriented across the longest inflow area
- Install provisions for draining to prevent standing water problems
- Clear the area of all debris
- Grade the approach to the inlet uniformly
- Drill weep holes into the side of the inlet
- Protect weep holes with screen wire and washed aggregate
- Seal weep holes when removing structure and stabilizing area
- It may be necessary to build a temporary dike to the downslope side of the structure to prevent bypass flow.

Block and Gravel Filter is a barrier formed around the storm drain inlet with standard concrete blocks and gravel. See the figure on the top of the next page an example for surface inlets.

- Maximum Height 12" above top of curb
- Recess the first row 2" into the ground for stability
- Support subsequent courses by placing a 2"x4" through the block opening
- Do **NOT** use mortar. Lay some blocks in the bottom row on their side on either side of the inlet to form a dewatering pool
- Place hardware cloth or comparable wire mesh with ½" openings over all block openings
- Place gravel on the cloth or mesh to an elevation just below the top of blocks and on slopes of 2:1 or flatter. An alternative design is a gravel donut.
- Inlet slope of 3:1
- Outlet slope of 2:1
- 12" wide level stone area between the structure and the inlet

- Inlet slope stones 3” in diameter or larger
- Use ½” to ¾” gravel on outlet slope at a minimum thickness of 12”
- Barrier should allow water to pond - separating sediment from runoff before entering the inlet - but allow all waters to overflow from severe storm events.
- Barriers should be inspected and sediment removed after each storm event. Sediment and gravel must be removed from travel ways immediately.

Plan View

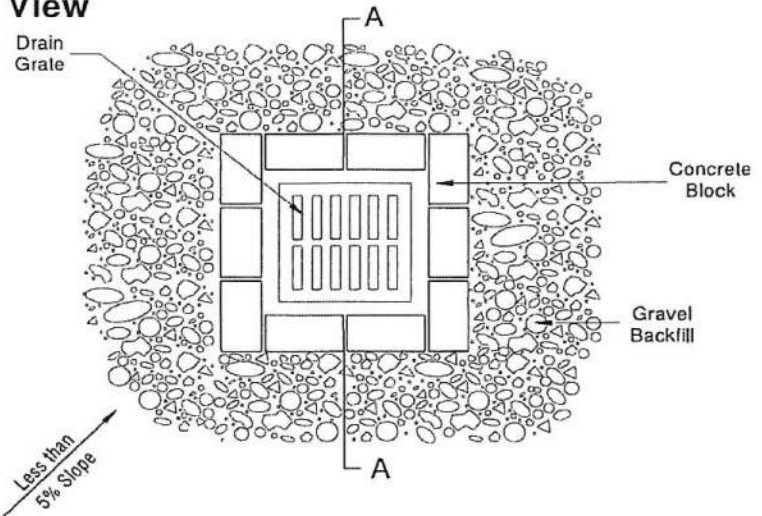

See the figure on the next page for inlets in the curb line.

Catch-basin Filters are inserts designed by manufacturers for limited sediment storage capacity, so increased inspection and maintenance is required - possibly daily. The maintenance requirements can be reduced by combining a catch-basin filter with another type of inlet protection.

Section A - A

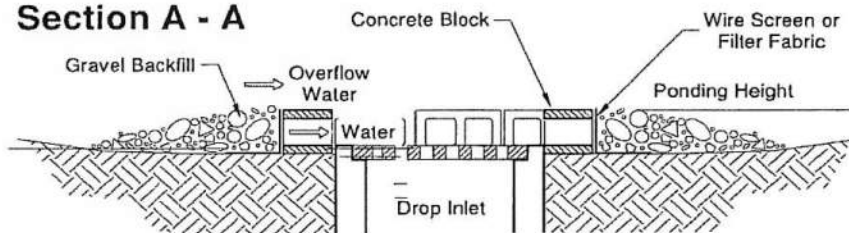

This type of inlet protection provides flow bypass without overflow and therefore may be a better method for inlets located along active rights-of-way.

- 5 cubic feet of storage
- De-watering provisions
- High-flow bypass that will not clog under normal use at a construction site.
- The catch-basin filter is inserted in the catch-basin just below the grating

Curb Inlet Protection with Wooden Weir is a barrier formed around a curb inlet with a wooden frame and gravel.

- Wire mesh with ½” openings
- Extra strength filter cloth
- Construct a frame
- Attach the wire and filter fabric to the frame
- Pile coarse washed aggregate against wire/fabric
- Place weight on frame anchors

Curb and Gutter Sediment Trap is usually a sandbag or rock berm filled with pea gravel or other aggregates) 12” high by 3’-0” wide in a horseshoe shape.

- Construct the shaped berm and face with coarse aggregate 3’-0” high by 3’-0” wide, at least 24” from the inlet.
- Construct a sediment trap on the outside of the berm that has been sized to sediment trap standards for protecting a culvert inlet.
- Barrier can be constructed of burlap or woven geo-textile fabric bags filled with gravel. The bags should be layered and packed tightly to form the barrier with a 1-bag-gap in the top row to create an overflow spillway.
- Trap should allow water to pond - separating sediment from runoff before overflowing the barrier and entering the inlet - but should allow all runoff from severe storm events to reach the inlet
- Barriers and traps should be inspected and sediment removed after each storm event. Sediment and

gravel must be removed from travel ways immediately.

Plan View

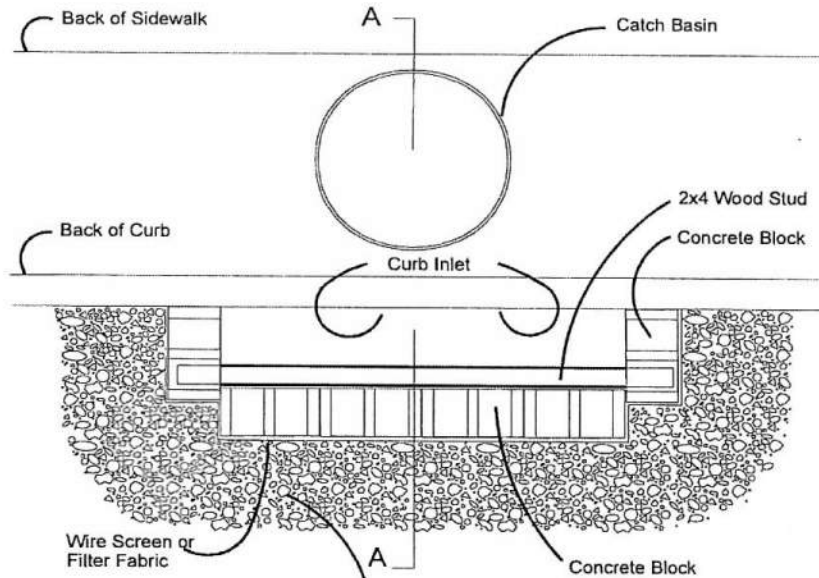

Section A - A

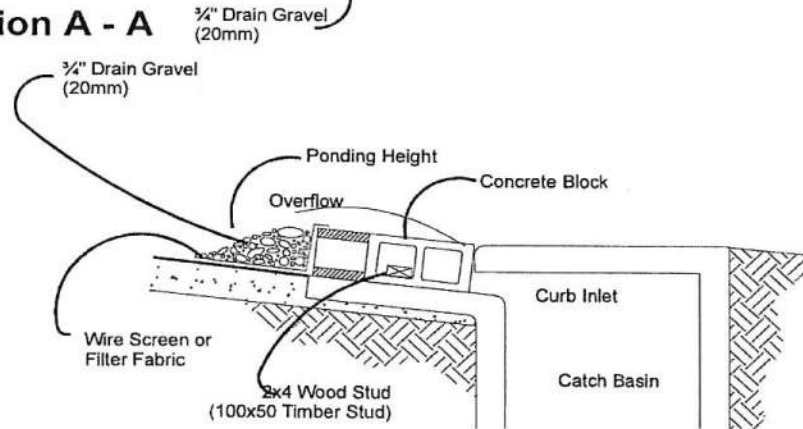

See the figure on the next page for a Curb & Gutter Sediment Trap example.

Similar to the Curb & Gutter Sediment Trap is the **J Hook**. This can be made using aggregate-filled bags like the trap above, but also can be easily made using a waddle or wattle (see BMP 321) and forming the fish-hook or J-shape. The leg of the “J” points the runoff into the “bowl” of the hook, which serves as the sediment trap. Once the “bowl” is filled with water, it runs out and enters the inlet. Because the “bowl” is already pulled back from the inlet, removing the sediment can be relatively easy since it has not pushed the wattle into the inlet. The hook can be “reinforced” by placing a section of perforated 4” drain pipe between the “bowl” and the inlet to help keep the wattle from entering the inlet’s opening(s). A series of J Hooks can be used to serve as a series of small sedimentation ponds or to catch and filter runoff before entering a street or drainage channel.

Plan View

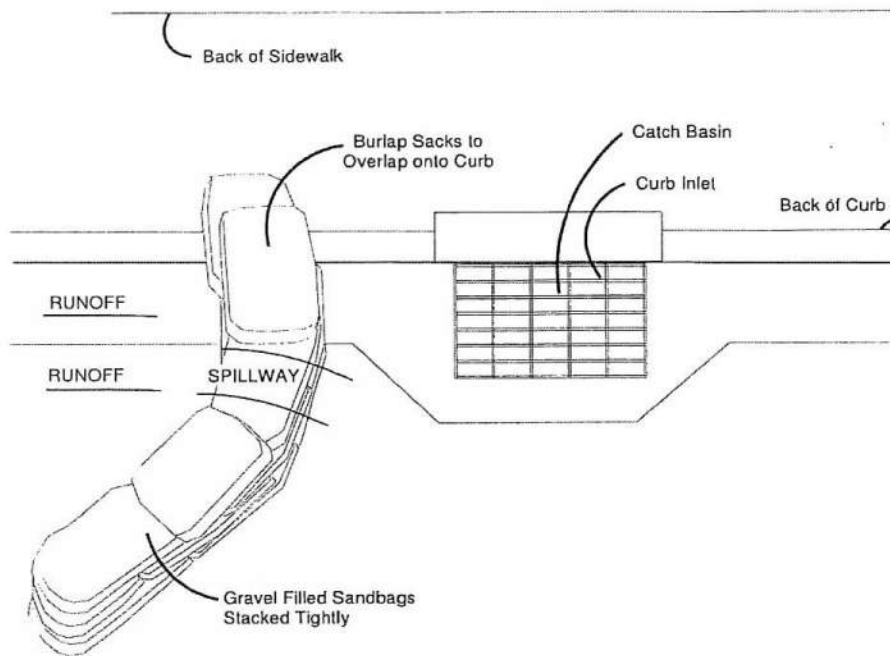

Maintenance Standards

- Regular maintenance is required to prevent ponding on paved, open-to-the-public, surfaces as well as flooding of adjoining and other nearby facilities and properties.
- Catch basin filters should be inspected frequently, especially after storm events. If the insert becomes clogged, it should be cleaned or replaced.
- For systems using stone filters: If the stone filter becomes clogged with sediment, the stones must be pulled away from the inlet and cleaned or replaced. Since cleaning of gravel at a construction site may be difficult, an alternative approach would be to use the clogged stone as fill and put fresh stone around the inlet.
- Do not wash sediment into storm drains while cleaning. Spread all excavated material evenly over the surrounding land area or stockpile and stabilize as appropriate.

BMP 340: Outlet Protection

Purpose

Outlet protection prevents scour at conveyance outlets; reduces the velocity of concentrated flows; and reduces the energy of concentrated flows - all of which will minimize the potential erosion downstream from the outfall's location.

Conditions of use

Protection is required at all outlets of ponds, pipes, ditches, or other conveyances and where runoff is conveyed to a natural or manmade drainage feature such as a stream, wetland, lake, or ditch.

Design and Installation Specifications

- The receiving channel at the outlet of a culvert shall be protected from erosion for a minimum of 6'-0" downstream and extending up the channel sides a minimum of 12" above the maximum tail-water elevation or 12" above the crown, whichever is higher. For large pipes (larger than 18" in diameter),

the outlet lining of the channel is lengthened to four times the diameter of the culvert. A rock lining or other design element can be used to achieve the same result in an equivalent area (i.e. the length of the apron times the width of the channel bottom).

- Standard wing-walls, and tapered outlets and paved channels should also be considered when appropriate for permanent culvert outlet protection.
- Organic or synthetic erosion blankets are usually more effective than rock, cheaper, and easier to install. Materials can be chosen using manufacturer product specifications. ASTM test results are available for most products and the designer can choose the correct material for the expected flow.
- With low flows, vegetation (including sod) can be effective.
- The following guidelines shall be used for stone outlet protection:
 - If the discharge velocity at the outlet is less than 5 fps and pipe slope is smaller than 1%, use 2" to 8" stone. Minimum thickness is 12".
 - For 5 to 10 fps discharge velocity at the outlet and pipe slope less than 3%, use 24" to 4'-0" stone. Minimum thickness is 24".
 - For outlets at the base of steep slope (or pipe slopes steeper than 10%), an engineered energy dissipater shall be used.
- Filter fabric or erosion control blankets should always be used under the stone to prevent scour and channel erosion.
- New pipe outfalls can provide an opportunity for fish habitat improvements. For example, an alcove of low-velocity water can be created by constructing the pipe outfall and associated energy dissipater back from the stream edge and digging a channel, over-widened to the upstream side, from the outfall. Bank stabilization, bio-engineering, and habitat features may be required for disturbed areas.
- Local drainage and development standards and guidelines shall be reviewed to verify that the materials called for in the plans are acceptable to the regulating jurisdiction.

Maintenance Standards

- Inspect and repair as needed.
- Add rock as needed to maintain the intended function.
- Clean energy dissipater(s) if sediment builds up.
- If stone or rock is used, it should be placed on a geo-textile fabric and inspected at least once every 6 months.
- Dislodged and/or missing quantities shall be replaced in a reasonable and timely fashion.

See BMP 341 for Energy Dissipaters BMPs if this item becomes an on-going maintenance issue.

BMP 341: Energy Dissipaters

Purpose

Swift moving water has large amounts of active energy associated with it that can wear away the soil, particularly by scour.

Conditions of Use

Energy dissipaters need to be placed in locations (such as below outfalls of point discharges that have significantly higher post-development flow rates than the overland sheet flows of pre-developed site conditions) that can prevent erosion of soils by slowing down the speed of the flowing water or by spreading out the area that the water interacts with.

Design and Installation Specifications

Energy can be dissipated through a variety of options. Taller vegetation will generally dissipate more energy than very short vegetation. Vegetation versus pavement will also disperse energy. Energy can also be

released by spreading out the flow instead of sending into a pipe or channel, or even trying to keep it contained in channels once a flow has been “condensed.” Reducing the depth of the flow also can reduce the energy of the flow. Unfortunately, if the steepness of the channel is allowed to increase, it will work against the energy dissipation that channel widening or “shallow”-ing attempts to reduce.

Maintenance Standards

Depending on what the device is made of and how much energy it is subjected to, it may need yearly maintenance or replacement. Annual review of its stability, connectivity, and location within the channel should occur.

Scour can develop in very short periods of time; or not appear at all. Bridges along with other under- and over-pass structures are particularly susceptible to scour so need to be reviewed every 2 to 3 years. Once scour begins to appear, reviews may need to be more frequently, unless preventative BMPs are placed into service quickly.

BMP 350: Square Grain Barrier

Purpose

To decrease the velocity of sheet flows and intercept and detain small amounts of sediment from disturbed areas of limited extent, preventing sediment from leaving the site. See the figure on the next page for details on square grain barriers.

Conditions of Use

Below disturbed areas subject to sheet and rill erosion.

- Square grain barriers are among the most used and **least effective BMPs**. The best use of a square grain bale is hand spread on the site.
- Where the size of the drainage area is no greater than ¼ acre per 100’-0” of barrier length; the maximum slope length behind the barrier is 100’-0”; and the maximum slope gradient behind the barrier is 2:1 where effectiveness is required for less than three months.
- **Under no circumstances should square grain barriers be placed or constructed in concentrated flows such as streams, channels, or ditches.** They are not an adequate method of silt control for anything other than sheet or overland flow.
- Square grain barriers should not be used where rock or hard surfaces prevent the full and uniform anchoring of the barrier.

Design and Installation Specifications

Bales shall be placed in a single row, lengthwise **on the contour**, with ends of adjacent bales tightly abutting one another.

- All bales shall be either wire-bound or string-tied. Square grain bales shall be installed so that bindings are oriented around the sides rather than along the tops and bottoms of the bales in order to prevent deterioration of the bindings. The barrier shall be entrenched and backfilled. A trench shall be excavated the width of a bale and the length of the proposed barrier to a minimum depth of 4”.
- The trench must be deep enough to remove all grass and other material that might allow underflow. After the bales are staked and chinked (filled by wedging), the excavated soil shall be backfilled against the barrier. Backfill soil shall conform to the ground level on the downhill side and built up to 4” against the uphill side of the barrier.
- Each bale shall be securely anchored by at least 2 stakes or rebar driven through the bale. The first stake in each bale shall be driven toward the previously laid bale to force the bales together. Stakes or rebar shall be driven deep enough into the ground to securely anchor the bales.
- Stakes should not extend above the bales but instead should be driven in flush with the top of the

bale for safety reasons.

- The gaps between the bales shall be chinked (filled by wedging) with straw to prevent water from escaping between the bales. Loose straw scattered over the area immediately uphill from a straw bale barrier tends to increase barrier efficiency. Wedging must be done carefully in order not to separate the bales.

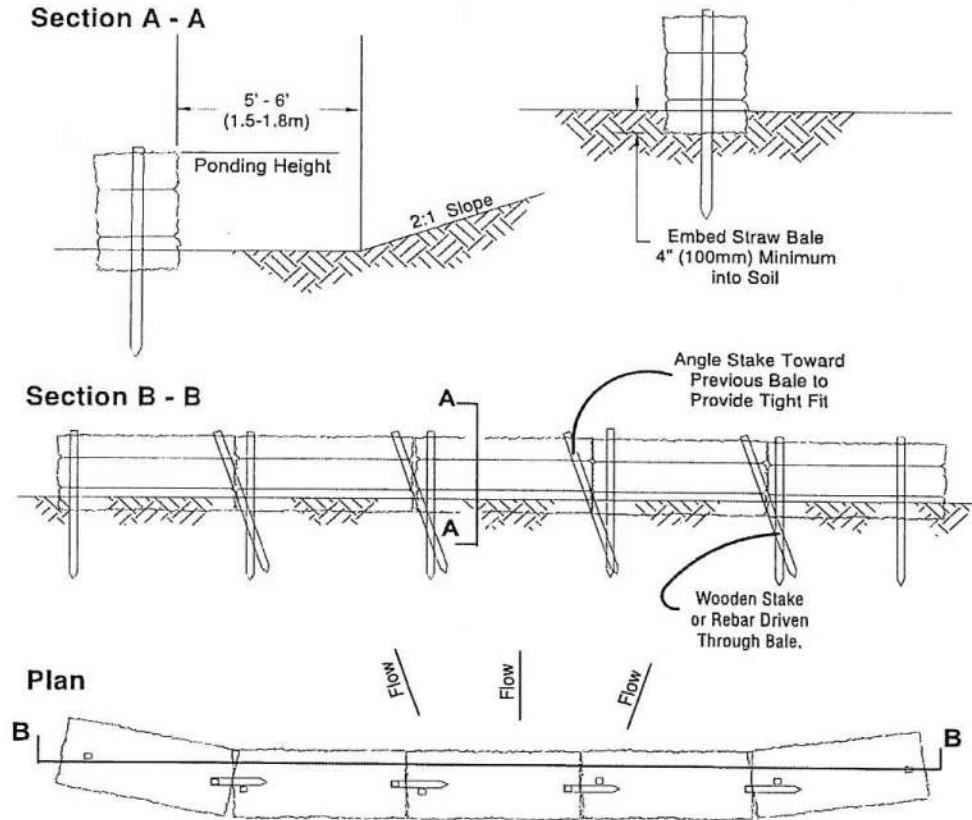

Maintenance Standards

- Square grain barriers shall be inspected immediately after each runoff event and at least daily during prolonged rainfall.
- Close attention shall be paid to the repair of damaged bales, end runs, and undercutting beneath bales. Necessary repairs to barriers or replacement of bales shall be accomplished promptly.
- Sediment deposits should be removed after each runoff event.
- Square grain bales must be removed when the level of deposition reaches approximately $\frac{1}{2}$ the height of the barrier.
- Any sediment deposits remaining in place after the Square grain barrier is no longer required shall be dressed to conform to the existing grade, prepared and seeded.
- Square grain bales used as temporary barriers shall be removed after project completion and the site has been stabilized to prevent sprouting of unwanted vegetation.

BMP 351: Embedded Reinforced Perimeter Sediment Barrier

Purpose

Use of an Embedded Reinforced Perimeter Sediment Barrier (ERPSB) reduces the transport of coarse sediment from a construction site by providing a temporary physical barrier to sediment and reducing the runoff velocities of overland flow. The reinforcing is placed behind the barrier supports it as sediment is

captured during a storm event. See the figure below for details on ERPSB construction.

Conditions of Use

- ERPSB may be used downslope of all disturbed areas.
- ERPSBs are not intended to treat concentrated flows, nor is it intended to treat substantial amounts of overland flow. Any concentrated flows must be conveyed through the drainage system to a sediment pond. The only circumstance in where overland flow can be treated solely by an ERPSB, rather than a sediment pond, is when the area draining to the fence is under 39,000 square feet and the flow rates are below 0.5 cfs.
- **Under no circumstances should ERPSBs be placed or constructed in concentrated flows such as streams, channels ditches.** They are not an adequate method of silt control for anything other than sheet or overland flow.
- ERPSBs should run across slopes to capture runoff. Barriers that run up-and-down slopes will collect runoff and concentrate it, which will result in a failure of the fence at any corners at the bottom where the Barrier is then “turned” to run across the slope.

Design and Installation Specifications

- Drainage area of less than 39,000 square feet or in combination with sedimentation basin in a larger site.
- Maximum slope steepness (perpendicular to the fence line): 1:1
- Maximum sheet or overland flow path length to the fence: 100’-0”
- No flows over 0.5 cfs
- The geo-textile used shall meet the standards in the table below. All properties listed are minimum average roll values. (i.e. the test result for any sampled roll in a lot shall meet or exceed the values shown.)

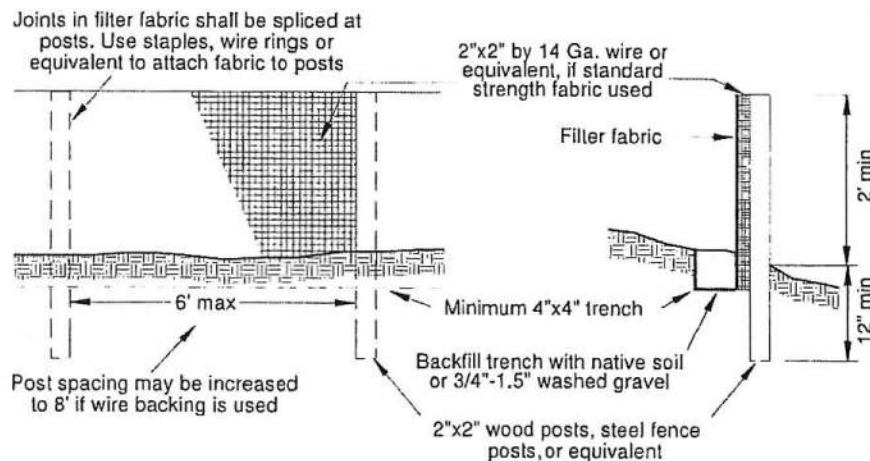

Table 12: Geo-textile Standards for Embedded Reinforced Perimeter Sediment Barriers

Polymeric Mesh AOS (ASTM D4751)	0.15 mm min. for all types (#100 sieve) 0.60 mm max. for slit-film woven (#30 sieve) 0.30 mm max. for all other types (#50 sieve)
Water Permittivity (ASTM D4491)	0.02 sec ⁻¹ minimum
Grab Tensile Strength (ASTM D4632)	100 lbs. min. for standard strength fabric 180 lbs. min. for extra-strength fabric
Grab Tensile Strength (ASTM D4632)	30% maximum
Ultraviolet Resistance (ASTM D4355)	70% minimum

- Standard strength fabrics shall be supported with woven-wire mesh with maximum 4” by 4” openings, safety fence, or jute mesh to increase the strength of the fabric. Fence materials are available that have synthetic mesh backing attached.

- Filter fabric material shall contain ultraviolet ray inhibitors and stabilizers to provide a minimum of 6 months of expected usable construction life at a temperature range of 0°F to 120°F.
- 100% biodegradable silt fence is available that is strong and long lasting. All temporary or construction BMPs shall be removed after the project is completed and stabilized.
- Standard Notes for construction plans and specifications follow in Appendix E. Refer to the figure below for standard ERPSB details.

The contractor shall install and maintain temporary barriers at the locations shown in the Plans. The barrier shall be constructed in the areas of clearing, grading, or drainage prior to starting those activities. A fence shall not function beyond the life of the contract, or 6 months - whichever is **SHORTER**. The barrier shall prevent soil carried by runoff water from going beneath, through, or over the top of the fence, but shall allow the water to pass through it.

The minimum height of the top of barrier shall be 24" and the maximum height shall be 30" above the original ground surface. The geo-textile shall be sewn together at the manufacturer, or at an approved location as determined by the Engineer, to form geo-textile lengths as required. All sewn seams shall be located at a support post. Alternatively, 2 sections of silt fence can be overlapped, provided the Contractor can demonstrate, to the satisfaction of the Engineer or local municipality, that the overlap is long enough and that the adjacent fence sections are close enough together to prevent silt-laden water from escaping through the fence at the overlap.

The geo-textile shall be attached on the upslope side of the posts and support system with staples, wire, and in accordance with the manufacturer's recommendations. The geo-textile shall be attached to the posts in a manner that reduces the potential for geo-textile tearing at the staples, wire, or other connection devices. Barrier back-up support for the geo-textile is dependent on the properties of the geo-textile selected for use. If wire or plastic back-up mesh is used, it shall be fastened securely to the upslope of the posts with the geo-textile being upslope of the support.

The geo-textile at the bottom of the fence shall be buried in a trench to a minimum depth of 8" below the ground surface on the **upstream** side of the fence posts. The trench shall be backfilled and the soil tamped in place over the buried portion of the geo-textile, such that no flow can pass beneath the fence and scouring can not occur. The wire or mesh support shall also extend into the trench a minimum of 4".

The fence posts shall be placed or driven a minimum of 18". A minimum depth of 12" is allowed if a minimum depth of 18" cannot be reached. Fence post depths shall be increased by 6" if the fence is located on slopes of 3:1 or steeper. The slope must be perpendicular to the fence. If required post depths cannot be obtained, the posts shall be adequately secured by bracing or guying to prevent overturning of the fence due to sediment loading. As all alternative, the spacing of the posts can be reduced to provide additional support to the fence.

ERPSBs shall be located on contour as much as possible, except at the ends of the fence, where the fence shall be turned uphill such that the silt fence captures the runoff water and prevents water from flowing around the end of the fence. If the fence must cross contours, with the exception of the ends of the fence, gravel check dams placed perpendicular to the back of the fence shall be used to minimize concentrated flow and erosion along the back of the fence. The gravel check dams shall be approximately 12" deep at the back of the fence. It shall be continued perpendicular to the fence at the same elevation until the top of the check dam intercepts the ground surface behind the fence.

The gravel check dams shall consist of crushed surfacing base course, gravel backfill for walls, or shoulder ballast. The gravel check dams shall be located every 10'-0" along the fence where the fence must cross contours. The slope of the fence line where contours must be crossed shall not be steeper than 3:1.

Wood, steel or equivalent posts shall be used. Wood posts shall have minimum dimensions of 2" by 2" by 36" minimum length, and shall be free of defects such as knots, splits, or gouges. Steel posts shall consist of either size ¾ rebar or larger; ASTM A120 steel pipe with a minimum diameter of 1-inch; U-, T-, L-, or C-shape steel posts with a minimum weight of 1.35 lbs./ft. or other steel posts having equivalent strength and bending resistance to the post sizes listed.

The spacing of the support posts shall be a maximum of 6'-0". Wire-back support shall consist of woven (not welded) steel wire with a maximum mesh spacing of 4", or a prefabricated polymeric mesh. The strength of the wire or polymeric mesh shall be more than 180 lbs. grab tensile strength. The polymeric mesh must

be as resistant to ultraviolet radiation as the geo-textile it supports.
 ERPSB installation using the slicing method specification details follows in the figure below.

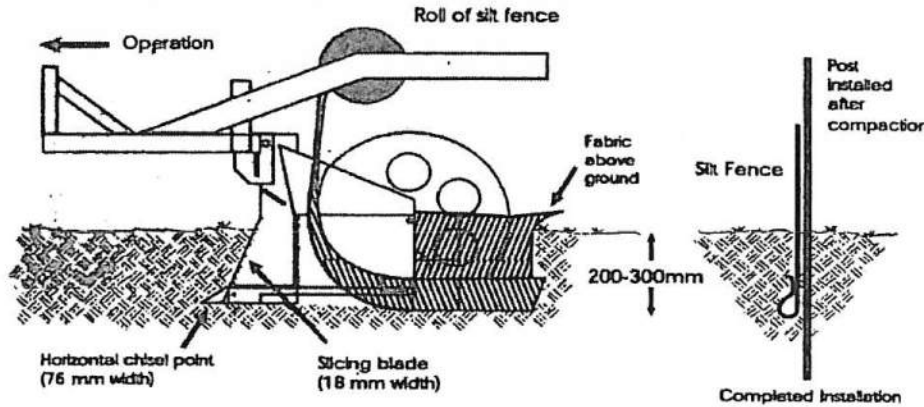
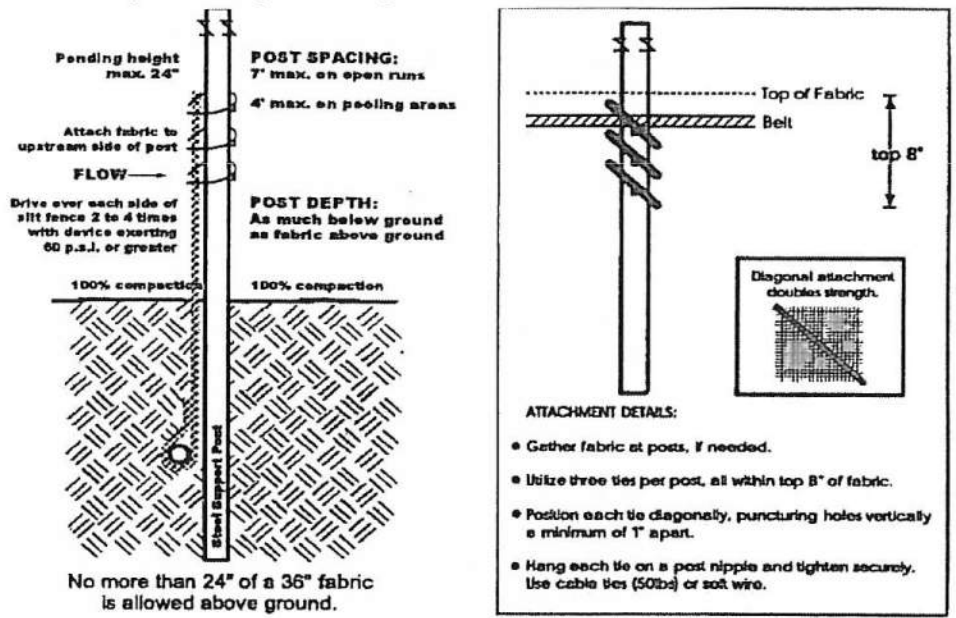

Vibratory plow is not acceptable because of horizontal compaction

1. The base of posts must be at least 2" to 4" above the top of the geo-textile fabric on the middle posts for ditch checks to drain properly. Use a string level to mark base points before installation.
2. Install posts 3'-0" to 4'-0" feet apart in critical retention areas and 5'-0" to 6'-0" feet apart in standard applications.
3. Install posts 24" deep on the downstream side of the barrier, and as close as possible to the fabric, enabling posts to support the fabric from upstream water pressure. The top of all posts should be at the top of the silt fence for the prevention of injuries due to falls onto the fence.
4. Attach the fabric to each post with 3 ties within the top 8" of the fabric. Attach each tie diagonally 45-degrees through the fabric, with each puncture at least 1" vertically apart. In addition, each tie should be positioned to hang on a post nipple to prevent sagging.
5. Wrap approximately 6" of fabric around the end posts and secure with 3 ties.
6. No more than 24" of a 36" fabric is allowed above ground level.
7. The rope lock system must be used in all ditch check applications.
8. The installation should be checked and corrected before compaction. Use a flat-bladed shovel to tuck fabric deeper into the ground if necessary.
9. Compaction is vitally important for effective results. Compact the soil immediately next to the fabric with the front wheel of the tractor, skid steer, or roller exerting at least 60 psi. Compact the upstream side first and then the downstream side. Repeat each side twice for a total of 4 trips.

Maintenance Standards

- Inspection is required at least after every rain event until the site above the BMP is stabilized to regulating standards. Inspections preferably would occur immediately **prior** to each predicted runoff events to make sure the barrier will in working conditions when the events happen.
- All damages shall be repaired immediately.
- If concentrated flows are evident uphill of the fence, they must be intercepted and conveyed to a sediment pond.
- It is important to check the uphill side of the fence for signs of the fence clogging and acting as a barrier to flow - resulting in channelization of flows parallel to the fence. If this occurs, replace the fence and remove all trapped sediment.
- Sediment deposits shall either be removed when the deposit reaches approximately 25% of the height of the ERPSB. A second barrier or sediment “catcher” shall be installed during the removal of the deposited materials from the first fence if the materials being removed, the ground, or the weather is damp and/or wet.
- If the geo-textile has deteriorated due to ultraviolet breakdown, it shall be replaced.
- All barriers shall be replaced at least once every 6 months on projects with longer construction lives.
- Once the site is stabilized, the barrier needs to be removed prior to filing a NOT with the local overseeing jurisdiction.

Chapter 4: Treatment BMPs

BMP 401: Sediment Trap

Purpose

A sediment trap is a small temporary ponding area with a gravel outlet used to collect and store sediment from sites cleared and/or graded during construction. Sediment traps, along with other perimeter controls, shall be installed before any land disturbance takes place in the drainage area. They also provide a location that allows sediment and other particles to settle out of the runoff before the water continues draining off-site.

Conditions of Use

Prior to leaving a construction site, stormwater runoff must pass through sediment pond or trap or other appropriate sediment removal best management practice. Non-engineered sediment traps may be used on-site prior to an engineered sediment trap or sediment pond to provide additional sediment removal capacity.

It is intended for use on sites where the tributary drainage area is smaller than 3.00 acres, with no unusual drainage features, and a projected build-out time of 6 months or less. The sediment trap is a temporary measure and shall be maintained until the site area is permanently protected against erosion.

Sediment traps and ponds are only effective in removing sediment down to about the medium silt size fraction. Runoff with sediment of finer grades (fine silt and clay) will pass through untreated - emphasizing the need to prevent erosion first and to control erosion overall before reaching the pond.

Whenever possible, sediment-laden water shall be discharged into on-site relatively level, vegetated areas (see BMP 334 – Vegetated Strip). This is the only passive way to effectively remove fine particles from runoff. Chemical treatments or filtrations can also be used to actively remove the particles, which can be particularly useful after initial treatment in a sediment trap or pond. The areas of release must be evaluated on a site-by-site basis in order to determine appropriate locations for and methods of releasing runoff. Vegetated wetlands shall not be used for this purpose. Frequently, it may be possible to pump water from the collection point at the downhill end of the site to an upslope vegetated area. Pumping shall only augment the treatment system - not replace it - due to the possibility of pump failure and/or runoff volume in excess of pump capacity.

All projects that are constructing permanent facilities for runoff quantity control should use the rough-graded or final-graded permanent facilities for traps and ponds. This includes combined facilities and infiltration facilities. When permanent facilities are used as temporary sedimentation facilities, all requirements of the more restrictive type (temporary or permanent) trap or pond must be met. If the requirements of the permanent facility are larger, the trap or pond may be initially constructed to those requirements, but shall be enlarged to comply with the permanent requirements before the project's NOT is filed for.

The permanent pond may be required by the local municipality to be divided into 2 cells - one for settling and the other for de-watering. Either a permanent or the temporary control structure (described in BMP 401, Temporary Sediment Pond) can be used. If a permanent control structure is used, it may be advisable to partially restrict the lower orifice with gravel or other clean large fill to increase residence time of the inflow while still allowing dewatering of the pond. A shut-off valve may be added to the control structure to allow complete retention of stormwater in emergency situations. In this case, an emergency overflow weir must be added. A skimmer may be used for the sediment trap outlet if approved, permitted, or required by the local municipality.

Design and Installation Specifications

- See the figure below for the cross-section of a typical trap.

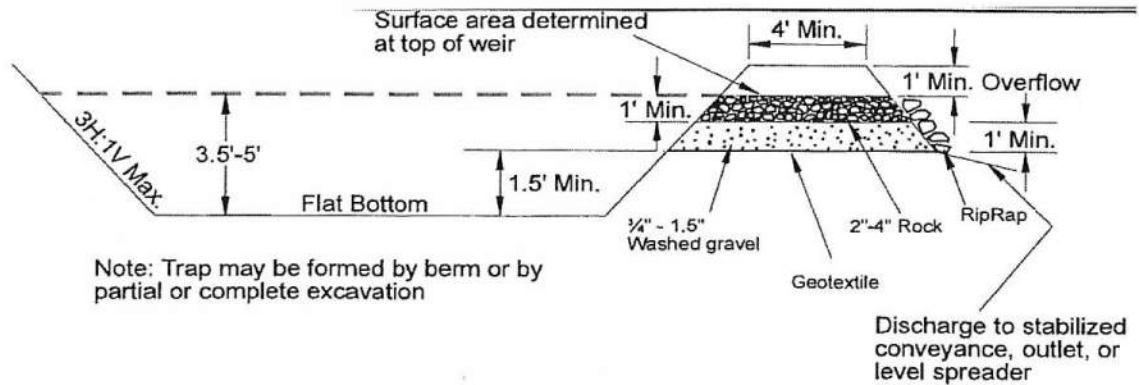

- See the figure below for the outlet details of a typical trap.

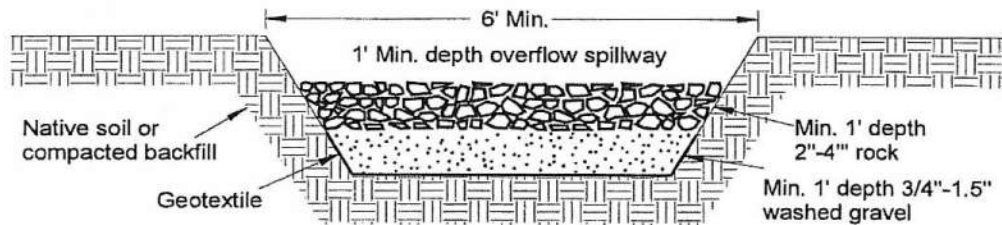

- If permanent runoff control facilities are part of the project, they can be used for sediment retention. (Most municipalities prefer that they are.)
- To determine the sediment trap geometry, first calculate the design surface area (*SA*) of the trap, measured at the invert of the weir. Use the following equation:

$SA = FS(Q_2/V_s)$ where

Q_2 = Design inflow based on the peak discharge from the developed 2-year runoff event from the contributing drainage area as computed in the hydrologic analysis. The 10-year peak flow shall be used if the project size, expected timing and duration of construction; downstream conditions warrant a higher level of protection; or as directed by jurisdictional personnel. If no hydrologic analysis is required, the Rational Method may be used.

V_s = The settling velocity of the soil particle of interest. The 0.02 mm (medium silt) particle with an assumed density of 2.65 g/cm³ has been selected as the particle of interest and has a settling velocity (V_s) of 0.00096 fps

FS = A safety factor of 2 to account for non-ideal settling.

Therefore, the equation for computing surface area becomes: $SA = 2 \times Q_2 / 0.00096$ or 2080 square feet per cfs of inflow. **NOTE:** Even if permanent facilities are used, they must still have a surface area that is at least as large as that derived from the above formula. If they do not, the pond must be enlarged.

- To aid in determining sediment depth, all sediment traps shall have a staff gauge with a prominent mark 1-foot above the bottom of the trap.
- Sediment traps may not be feasible on utility projects due to the limited work space or the short-term nature of the work. Portable tanks may be used in place of sediment traps for utility projects.

Maintenance Standards

- Sediment shall be removed from the trap when it reaches 12" in depth.
- Any damage to the pond embankments or slopes shall be repaired.
- Inspect weekly and after each rain event until the site upstream has been stabilized.
- Once the site has been stabilized, inspections should occur quarterly and after each major rain event to check for erosion, sediment accumulation; mowing; trash removal; other defects and needed repairs.

BMP 402: Temporary Sediment Pond

Purpose

Sediment ponds remove sediment from runoff originating from disturbed areas of the site. Sediment ponds are typically designed to remove sediment no smaller than medium silt (0.02 mm). Consequently, they usually reduce turbidity only slightly.

Conditions of Use

Prior to leaving a construction site, stormwater runoff must pass through a sediment pond or other appropriate sediment removal best management practice.

A sediment pond shall be used where the contributing drainage area's runoff can not otherwise be 1) reduced to pre-existing conditions, or 2) sufficiently treated to remove sediment and other contaminants of the water cycle. Ponds must be used in conjunction with erosion control practices to reduce the amount of sediment flowing into the basin.

Design and Installation Specifications

- Sediment basins may be installed only on sites where failure of the structure would not result in loss of life; damage to homes or buildings; or interruption of use or service of public roads or utilities. Also, sediment traps and ponds are attractive to children and can be very dangerous. Compliance with local ordinances regarding health and safety must be addressed. If fencing of the pond is required, the type of fence and its location shall be shown on the SWP3 plan.
- All structures are subject to the Arkansas Dam Safety Regulations.
- See the figure below for a typical pond plan view as shown on a SWP3

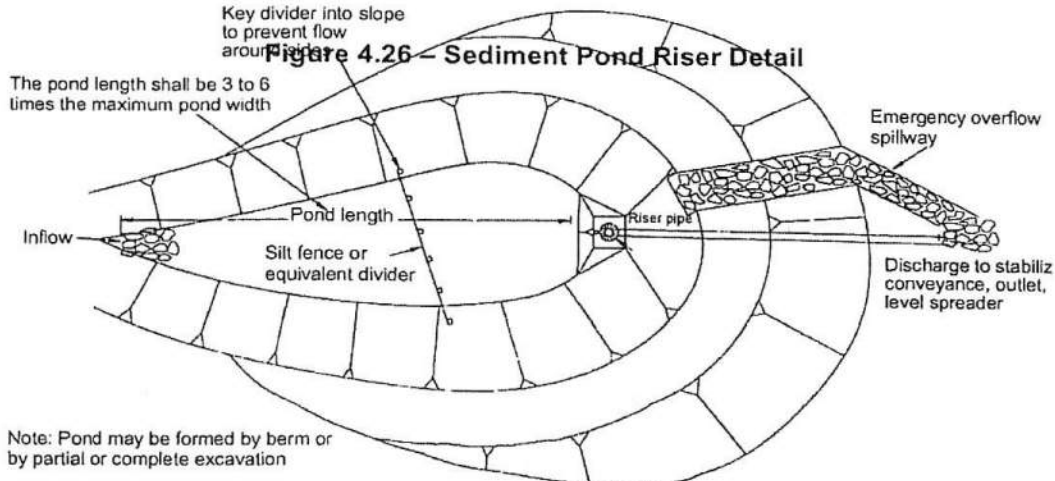

- See the figure on the top of the next page for the cross-section of a pond with a riser pipe and dewatering device.
- If permanent runoff control facilities are part of the project, they can be used for temporary sediment retention. All requirements of a sediment basin must be met. This may require enlarging the temporary basin to comply with the requirements of the permanent basin. If permanent control structures are used, it may be advisable to partially restrict the lower orifice with gravel or other clean large fill to increase residence time while still allowing the basin to dewater.
- Use of infiltration facilities for sedimentation basins during construction tends to clog the soils and reduce their capacity to infiltrate. If infiltration facilities are to be used, the sides and bottom of the facility must only be rough excavated to a minimum of 24" above final grade. Final grading of the infiltration facility shall occur only when all contributing drainage areas have been fully stabilized.

An infiltration pre-treatment facility should be fully constructed and used with the sedimentation basin to help prevent clogging.

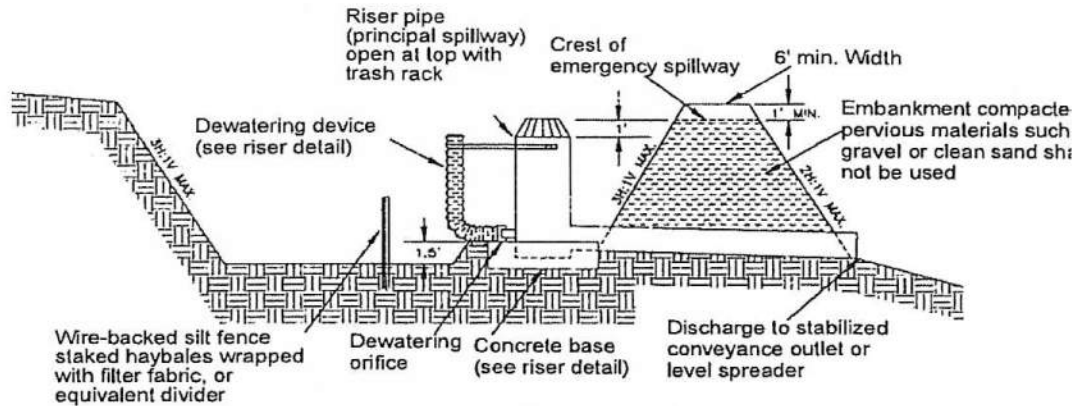

- See the figure below for a typical pond riser detail

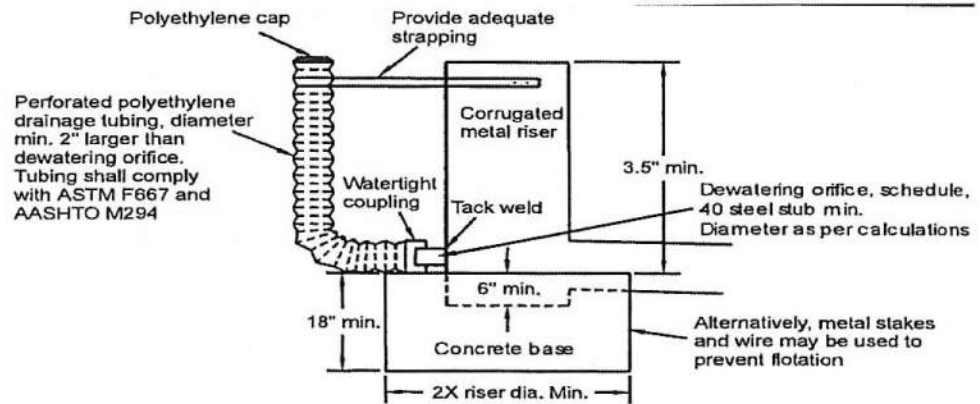

- Determining Pond Geometry:

The basic geometry of the pond can now be determined using the following design criteria:

- o Required surface area (see BMP 401)
- o Minimum 42" depth from top of riser to bottom of pond
- o Maximum 3:1 interior side slopes and maximum 2:1 exterior slopes. The interior slopes can be increased to a maximum of 2:1 if fencing is provided at or above the maximum water surface.
- o 12" of freeboard between the top of the riser and the crest of the emergency spillway
- o Flat bottom
- o Minimum 12" deep spillway
- o Length-to-width ratio should be between 2:1 and 6:1
- o Sizing of Discharge Mechanisms

The outlet for the basin consists of a combination of principal and emergency spillways. These outlets must pass the peak runoff expected from the contributing drainage area for a 100-year storm. If, due to site conditions and basin geometry, a separate emergency spillway is not feasible, the principal spillway must pass the entire peak runoff expected from the 100-year storm. However, an attempt to provide a separate emergency spillway should always be made. Available spillway storage must begin at the principal spillway riser crest.

The principal spillway designed may result in some reduction in the peak rate of runoff. However, if the basin for a permanent stormwater detention pond is used for a temporary sedimentation basin, the control structure for the permanent pond can be used to maintain pre-development discharge limitations. The size of the basin; the expected life of the construction project; the anticipated downstream effects;

and the anticipated weather conditions during construction should be considered to determine the need of additional discharge control.

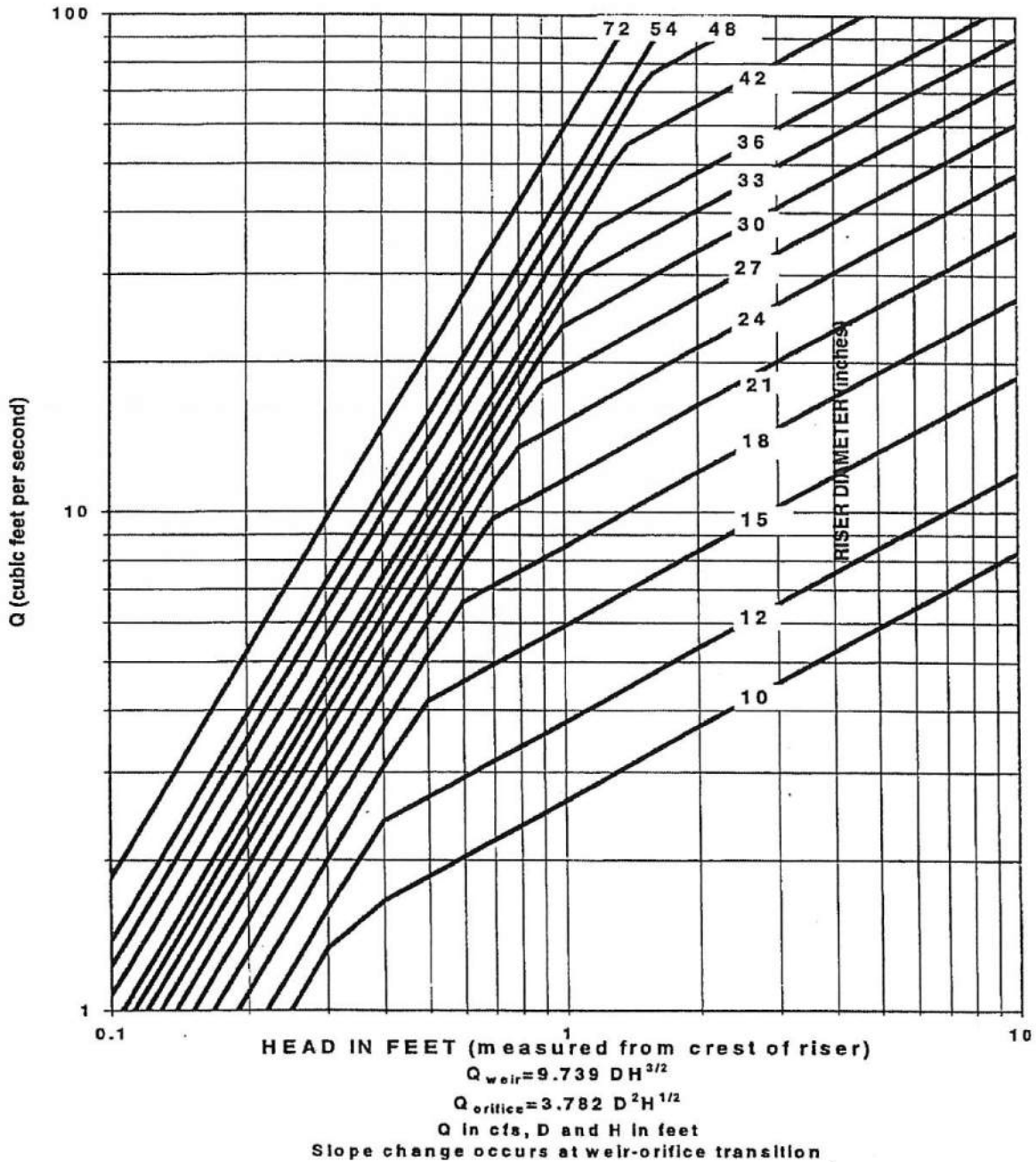

Principal Spillway: Determine the required diameter for the principal spillway (riser pipe). The diameter shall be the minimum necessary to pass the pre-developed 10-year peak flow (Q_{10}). **Note:** A permanent control structure may be used instead of a temporary riser.

Emergency Overflow Spillway: Determine the required size and design of the emergency overflow spillway for the developed 100-year peak flow.

Dewatering Orifice: Determine the size of the dewatering orifice(s) (minimum 1" diameter) using a modified version of the discharge equation for a vertical orifice and a basic equation for the area of a circular orifice. Determine the required area of the orifice.

The vertical, perforated tubing connected to the dewatering orifice must be at least 2" larger in diameter than the orifice to improve flow characteristics. The size and number of perforations in the tubing should be large enough so that the tubing does not restrict flow. The orifice should control the flow rate.

- Additional Design Specifications

The pond preferably would be divided into two roughly equal volume cells by a permeable divider that will reduce turbulence while allowing movement of water between cells. The divider shall be at least 50% the height of the riser and a minimum of 12" below the top of the riser.

Wire-backed, 24" to 36" high, extra strength filter fabric supported by treated 4"x4"s can be used as a divider. Alternatively, staked straw bales wrapped with filter fabric (geo-textile) may be used. If the pond is more than 6'-0" deep, a different mechanism must be proposed. A native stone embankment is one acceptable method of separation for deeper ponds. Other designs that satisfy the intent of this provision are allowed as long as the divider is permeable, structurally sound, and designed to prevent erosion under or around the barrier.

To aid in determining sediment depth, 12" intervals shall be prominently marked on the riser. If an embankment of more than 6'-0" is proposed, the pond must comply with the criteria regarding dam safety for detention BMPs.

- The most common structural failure of sedimentation basins is caused by piping. Piping refers to two phenomena:
 1. Water seeping through fine-grained soil, eroding the soil grain by grain and forming pipes or tunnels; and,
 2. Water under pressure flowing upward through a granular soil with a head of sufficient magnitude to cause soil grains to lose contact with each other and their capability for supporting those grains above them.

The most critical construction sequences to prevent piping will be:

- a. Tight connections between riser and barrel and other pipe connections;
- b. Adequate anchoring of riser;
- c. Proper soil compaction of the embankment and riser footing; and
- d. Proper construction of anti-seep devices

Maintenance Standards

- Sediment shall be removed from the pond when it reaches 12" in depth.
- Any damage to the pond embankments or slopes shall be repaired.

BMP 410: Retention vs. Detention Ponds

Purpose

Retention ponds hold water back. They typically hold water until it infiltrates into the ground or evaporates. Detention ponds temporarily contain water, or slow release it into drainage ways.

Conditions of Use

Retention ponds should be used in areas where it can more easily be infiltrated into the ground or held at a constant elevation without the need for pumping in "new" water from ground sources, adjacent surface waters, or municipal water supplies.

Detention ponds should be used in locations where their discharge will not exacerbate downstream conditions.

Design and Installation Specifications

Retention ponds should be sized to hold the entire design storm of the municipality that they are located in, or in more karstic areas, whatever the ground infiltration rate will support.

Detention ponds should also be designed to the standards of the municipality that they are located in as well as being sized in consideration of how upstream storm event flows will meet their discharges during the same storm event.

Maintenance Standards

If retention ponds have dry periods, they should be cleaned and mowed, if necessary, during their dry periods. If they do not have dry periods, they may require having the water level drawn down every few years so that the removal of accumulations from within the pond itself can occur. Accumulations may include gross solids, invasive or excessive vegetation, or natural or man-made items that could disrupt the effectiveness of the pond.

Detention ponds also will need to be mowed or brush-hogged at least once a year to maintain the vegetation in and around it. Accumulations of gross solids, invasive or excessive vegetation, or natural or man-made items that could disrupt the effectiveness of the pond should be removed in similar time frames as those of retention ponds.

BMP 420: De-watering

Purpose

De-watering a pond or similar feature is a way of separating water from the potential pollutants it contains.

Conditions of Use

If water can not be passively treated to remove its pollutants, it may need to go through a de-watering process before being released to a natural or man-made drainage way.

Design and Installation Specifications

The conditions of a receiving water will determine how treated a runoff must be before its release to drainage ways. If a receiving water has a TMDL or other maximum loading requirement placed on it, additional treatment - such as de-watering - may be required to remove more pollutants than most BMPs can provide.

One example of de-watering BMP is manufactured enclosed filter bag that water is pumped into from a sediment pond or trap. The bag's construction is finely controlled to maintain the very small openings in the bag's fabric weave. The water slowly soaks through the bag. Once the water has all passed through the bag, it can be sliced open so the solids inside can be collected for replacement on-site or for being mixed in with other decaying organic materials to make mulch or other soil amendments.

Maintenance Standards

Follow manufacturer's specifications.

BMP 421: Turbidity Removal

Purpose

When the amount of turbidity is pertinent to the receiving water of a construction site.

Conditions of Use

Should be used in a pond or trap or other water body treatment facility. Temperature can affect the way water reacts with the items within it so can also affect how turbid water can appear. If the water body that the

turbidity is trying to be removed from is large enough to go through water turn-over or has sufficient amount of animal life within its borders, treatment may be more difficult.

Design and Installation Specifications

Installations should take into account not only the amount of turbidity that needs to be removed, but also the properties of the water body itself. If the water body is expected to even partially freeze, the turbidity removal process or device will need to allow room for the expansion of the water without destroying or damaging the device(s) or its parts.

Maintenance Standards

Follow manufacturer's specifications.

BMP 430: Chemical Treatments

Purpose

Turbidity is difficult to control once fine particles are suspended in stormwater runoff from a construction site. Sedimentation ponds are effective at removing larger particulate matter by gravity settling, but are ineffective at removing smaller particulates such as clays and fine silts. Sediment ponds are typically designed to remove sediment no smaller than medium silt (0.02 mm). Chemical treatments may be used to reduce the turbidity of stormwater runoff.

Conditions of Use

Chemical treatment can reliably provide exceptional reductions of turbidity and associated pollutants. Very high turbidities can be reduced to levels comparable to what is found in streams during dry weather. Traditional BMPs used to control soil erosion and sediment loss from sites under development may not be adequate to ensure compliance with the water quality standard for turbidity in the receiving water. Chemical treatment may be required to protect streams from the impact of turbid stormwater discharges, especially when construction is to proceed through the wet season.

Formal written approval from the State and Local Permitting Authorities is required for the use of chemical treatment regardless of the site's size. The intention to use Chemical Treatment shall be indicated on the NOI for coverage under the General Construction Permit. Chemical treatment systems should be designed as part of the Construction SWPPP, not after the fact. Chemical treatment may be used to correct problem sites in limited circumstances with formal written approval from Permitting Authority. The municipality's review authority must be notified at the application phase of the project review (or the time that the determination on the project is performed) that chemical treatment is proposed. If it is added after this stage, an addendum will be necessary and may result in a delay of the project's approval.

Design and Installation Specifications

See Appendix D for background information on chemical treatment.

Criteria for Chemical Treatment Product Use: Chemically treated stormwater discharged from construction sites must be non-toxic to aquatic organisms. The following protocol shall be used to evaluate chemicals proposed for stormwater treatment at construction sites. Authorization to use a chemical in the field based on this protocol does not relieve the applicant from responsibility for meeting all discharge and receiving water criteria applicable to a site.

- Treatment chemicals must be approved by EPA for potable water use.
- Petroleum-based polymers are prohibited.
- Prior to authorization for field use, jar tests shall be conducted to demonstrate that turbidity reduction necessary to meet the receiving water criteria can be achieved. Test conditions, including but not limited to raw water quality and jar test procedures, should be indicative of field conditions.

Although these small-scale tests cannot be expected to reproduce performance under field conditions, they are indicative of treatment capability.

- Prior to authorization for field use, the chemically treated stormwater shall be tested for aquatic toxicity. Applicable procedures shall be used. Testing shall use stormwater from the construction site at which the treatment chemical is proposed for use or a water solution using soil from the proposed site.
- The proposed maximum dosage shall be at least a factor of 5 lower than the NOEC.
- The approval of a proposed treatment chemical is conditional AND subject to full-scale bio-assay monitoring of treated stormwater at the construction site where the proposed treatment chemical is to be used.
- Treatment chemicals that have already passed the above testing protocol do not need to be re-evaluated. Contact ADEQ office for a list of treatment chemicals that have been evaluated and are currently approved for use within the State of Arkansas.

Treatment System Design Considerations: The design and operation of a chemical treatment system should take into consideration the factors that determine optimum, cost-effective performance. It may not be possible to fully incorporate all of the classic concepts into the design because of practical limitations at construction sites. Nonetheless, it is important to recognize the following:

- The right chemical must be used at the right dosage. A dosage that is either too low or too high will not produce the lowest turbidity. There is always an optimum dosage rate. This is a situation where the adage “adding more is always better” is not the case.
- The coagulant must be mixed rapidly into the water to insure proper dispersion.
- A flocculation step is important to increase the rate of settling; to produce the lowest turbidity; and to keep the dosage rate as low as possible.
- Too little energy input into the water during the flocculation phase results in flocs that are too small and/or insufficiently dense. Too much energy can rapidly destroy floc as it is formed.
- Since the volume of the basin is a determinant in the amount of energy per unit volume, the size of the energy input system can be too small relative to the volume of the basin.
- Care must be taken in the design of the withdrawal system to minimize outflow velocities and to prevent floc discharge. The discharge should be directed through a physical filter such as a vegetated swale that would catch any unintended floc discharge.

Treatment System Design: Chemical treatment systems shall be designed as batch treatment systems using either ponds or portable trailer mounted tanks. Flow-through continuous treatment systems are not allowed at this time. A chemical treatment system consists of the stormwater collection system (either temporary diversion or the permanent site drainage system); a storage pond; pumps; a chemical feed system; treatment cells; and inter-connecting piping.

The treatment system shall use a minimum of 2 lined treatment cells. Multiple treatment cells allow for clarification of treated water while other cells are being filled or emptied. Treatment cells may be ponds or (portable or permanent) tanks. Ponds with constructed earthen embankments taller than 6'-0" high require special engineering analysis.

The following equipment should be located in an operational shed:

- the chemical injector;
- secondary containment for acid, caustic, buffering compound, and/or treatment chemicals;
- emergency shower and eyewash, and
- monitoring equipment which consists at least one pH meter and one turbidity meter.

Sizing Criteria: The combination of the storage pond or other holding area and treatment capacity should be large enough to treat stormwater from events lasting multiple days. It is recommended that at a minimum the storage pond or other holding area should be sized to hold 1.5 times the runoff volume of the 10-year, 24-hour storm event. Bypass should be provided around the chemical treatment system to accommodate extreme storm events, and runoff volume shall be calculated. If no hydrologic analysis is required for the site, the Rational Method may be used.

Primary settling should be encouraged in a storage pond. A fore-bay with access for maintenance may be beneficial.

There are 2 opposing considerations in sizing the treatment cells. A larger cell is able to treat a larger volume of water each time a batch is processed. However, the larger the cell, the longer the time required to empty the cell. A larger cell may also be less effective at flocculation and therefore require a longer settling time. The simplest approach to sizing the treatment cell is to multiply the allowable discharge flow rate times the desired drawdown time. Typically, a 4-hour drawdown time allows one batch per cell per 8-hour work period, given 1 hour of flocculation followed by 2 hours of settling.

The permissible discharge rate governed by potential downstream effect can be used to calculate the recommended size of the treatment cells. The following discharge flow rate limits shall apply:

- If the discharge is directly or indirectly to a stream, the discharge flow rate shall not exceed 50% of the peak flow rate of the 2-year, 24-hour event for all storm events up to the 10-year, 24-hour event.
- If discharge is occurring during a storm event equal to or greater than the 10-year, 24-hour event, the allowable discharge rate is the peak flow rate of the 10-year, 24-hour event.
- Discharge to a stream should not increase the stream flow rate by more than 10%.
- If the discharge is directly to a lake, major receiving water or an infiltration system, there is no discharge flow limit.
- If the discharge is to a municipal storm drainage system, the allowable discharge rate may be limited by the capacity of the public system. It may be necessary to clean the municipal storm drainage system prior to the start of the discharge to prevent scouring solids from within the drainage system.
- Runoff rates shall be calculated using the methods for the pre-developed condition. If no hydrologic analysis is required for the site, the Rational Method may be used.

Maintenance Standards

Monitoring:

The following monitoring shall be conducted. Test results shall be recorded on a daily log kept on-site:

Operational Monitoring

- pH, conductivity (as a surrogate for alkalinity), turbidity and temperature of the untreated stormwater
- Total volume treated and discharged
- Discharge time and flow rate
- Type and amount of chemical used for pH adjustment
- Amount of polymer used for treatment
- Settling time

Compliance Monitoring

- pH and turbidity of the treated stormwater
- pH and turbidity of the receiving water

Bio-monitoring

Treated stormwater shall be tested for acute (lethal) toxicity. Bio-assays shall be conducted by a laboratory accredited by the State, unless otherwise approved by ADEQ. **The performance standard for acute toxicity is no-statistically-significant-difference in survival between the control and 100% chemically treated stormwater.**

All toxicity tests shall meet quality assurance criteria and test conditions in the most recent versions of the EPA test method and Ecology Publication WQ-R-95-80, Laboratory Guidance and Whole Effluent Toxicity Test Review Criteria.

Bio-assays shall be performed on the first 5 batches and on every 10th batch thereafter; or as otherwise approved by the municipality or ADEQ. Failure to meet the performance standard shall be immediately reported to the municipality or ADEQ.

Discharge Compliance:

Prior to discharge, each batch of treated stormwater must be sampled and tested for compliance with pH and turbidity limits. These limits may be established by the water quality standards or a site-specific discharge permit.

Sampling and testing for other pollutants may also be necessary at some sites. Turbidity must be within 5 NTUs of the background turbidity. Background is measured in the receiving water, upstream from the

treatment process discharge point. pH must be fall between 6.5 and 8.5 standard units and not cause a change in the pH of the receiving water larger than 0.2 standard units. It is often possible to discharge treated stormwater that has a lower turbidity than the receiving water and that matches the pH.

Treated stormwater samples and measurements shall be taken from the discharge pipe or another location representative of the nature of the treated stormwater discharge. Samples used for determining compliance with the water quality standards in the receiving water shall not be taken from the treatment pond prior to decanting. Compliance with the water quality standards is determined in the receiving water.

Operator Training: Each contractor who intends to use chemical treatment shall be trained by an experienced contractor on an active site for at least 40 hours.

Standard BMPs: Surface stabilization BMPs should be implemented on site to prevent significant erosion. All sites shall use a truck wheel wash to prevent tracking of sediment off-site.

Sediment Removal and Disposal:

- Sediment shall be removed from the storage or treatment cells as necessary. Typically, sediment removal is required at least once during a wet season and at the decommissioning of the cells. Sediment remaining in the cells between batches may enhance the settling process and reduce the required chemical dosage.
- Sediment may be incorporated into the site away from drainages.

BMP440: Filtration

Purpose

Filtration removes sediment from runoff originating from disturbed areas on-site.

Conditions of Use

Traditional BMPs used to control soil erosion and sediment loss from sites under development may not be adequate to ensure compliance with the water quality standard for turbidity in the receiving water.

Filtration may be used in conjunction with gravity settling to remove sediment as small as fine silt (0.5 μm). The reduction in turbidity will be dependent on the particle size distribution of the sediment in the stormwater. In some circumstances, sedimentation and filtration may achieve compliance with the water quality standard for turbidity. Unlike chemical treatment, the use of construction stormwater filtration does not require approval from ADEQ. Filtration may also be used in conjunction with polymer treatment in a portable system to assure capture of the flocculated solids.

Filtration with sand media has been used for more than 100 years to treat water and wastewater.

Design and Installation Specifications

Background Information: The use of sand filtration for treatment of stormwater has developed recently - generally to treat runoff from streets, parking lots, and residential areas. The application of filtration to construction stormwater treatment is currently under development.

2 types of filtration systems may be applied to construction stormwater treatment: rapid and slow. Rapid sand filters are the typical system used for water and wastewater treatment. They can achieve relatively high hydraulic flow rates (on the order of 2 to 20 gpm/sf), because they have automatic backwash systems to remove accumulated solids. In contrast, slow sand filters have very low hydraulic rates (on the order of 0.02 gpm/sf), because they do not have backwash systems. To date, slow sand filtration has generally been used to treat stormwater. Slow sand filtration is mechanically simple in comparison to rapid sand filtration but requires a much larger filter area.

Filtration Equipment Sand media filters are available with automatic backwashing features that can filter to 50 μm particle size. Screen or bag filters can filter down to 5 μm . Fiber wound filters can remove

particles down to 0.5 μm . Filters should be sequenced from the largest to the smallest pore opening. Sediment removal efficiency will be related to particle size distribution in the stormwater.

Treatment Process Description Stormwater is collected at interception point(s) on-site to be diverted to a sediment pond or tank for storage and removal of large sediment from the stormwater before being treated by the filtration system. The stormwater is pumped from the trap, pond, or tank through the filtration system in a rapid sand filtration system. Slow sand filtration systems are designed as flow through systems using gravity. If large volumes of concrete are being poured, pH adjustment may be necessary.

Maintenance Standards

- Rapid sand filters typically have automatic backwash systems that are triggered by a pre-set pressure drop across the filter. If the backwash water volume is not large or substantially more turbid than the stormwater stored in the holding pond or tank, backwash return to the pond or tank may be appropriate. However, land application or another means of treatment and disposal may be necessary.
- Screens, bags, and fiber filters must be cleaned and/or replaced when they become clogged.
- Sediment shall be removed from the storage and/or treatment ponds as necessary. Typically, sediment removal is required once or twice during a wet season and at the decommissioning of the ponds.

Appendix A: Planning

A.1 General Guidelines

A.1.1 What is a Construction Stormwater Pollution Prevention Plan?

A.1.2 What is an Adequate Plan?

A.1.3 General Principles

A.2 Step-By-Step Procedure

A.2.1 Step 1 - Data Collection and Analysis

A.2.2 Step 2 - Construction SWPPP Development and Implementation

A.3 Construction SWPPP Requirements

A.3.1 Narrative

A.3.2 Drawings

A.1 General Guidelines

A.1.1 What is a Construction Stormwater Pollution Prevention Plan?

The Construction SWPPP is a document that describes the potential for pollution problems on a construction project. The Construction SWPPP explains and illustrates the measures to be taken on the construction site to control those problems. A Construction SWPPP for projects that adds, clears, or replaces impervious surface must have a narrative as well as drawings and details. The local permitting authority must review these Construction SWPPPs. The local permitting authority may allow single-family home construction projects to prepare a simpler Construction SWPPP, consisting of a checklist and a plot plan.

While it is a good idea to include standards and specifications from the Construction SWPPP in the contract documents, the Construction SWPPP should be a separate document that can stand alone. The Construction SWPPP must be located on the construction site, or within reasonable access to the site, or at another approved location as defined by either ADEQ or the local municipality for construction and inspection personnel; although, a copy of the drawings must be kept on the construction site at all times.

As site work progresses, the plan must be modified to reflect changing site conditions, and is subject to the rules for plan modification by the local permitting authority.

The owner or lessee of the land being developed has the responsibility for Construction SWPPP preparation and submission to local authorities. The owner or lessee may designate someone (i.e., an engineer, architect, contractor, etc.) to prepare the Construction SWPPP, but he/she retains the ultimate responsibility.

A.1.2 What is an Adequate Plan?

An adequate Construction SWPPP includes a narrative and drawings. The narrative is a written statement to explain and justify the pollution prevention decisions made for a particular project. The narrative contains concise information about existing site conditions, construction schedules, and other pertinent items that are not contained on the drawings. The drawings and notes describe where and when the various BMPs should be installed, the performance the BMPs are expected to achieve, and actions to be taken if the performance goals are not achieved.

On construction sites that discharge to a surface water body, the primary concern in the preparation of the Construction SWPPP is compliance with ADEQ regulations. A step-by-step procedure is recommended for the development of the Construction SWPPPs. The checklists in Appendix G may be helpful in preparing and reviewing the Construction SWPPP.

On construction sites that infiltrate all stormwater runoff, the primary concern in the preparation of the Construction SWPPP is the protection of the infiltration facilities from fine sediments during the construction phase and protection of ground water from other pollutants. Several of the other elements are very important at these sites as well, such as marking the clearing limits, establishing the construction access, and managing the project.

A.1.3 General Principles

The following general principles should be applied to the development of the Construction SWPPP.

- The duff layer, native topsoil, and natural vegetation should be retained in an undisturbed state to the maximum extent practicable.
- Prevent pollutant release. Select source control BMPs as a first line of defense. Prevent erosion rather than treat turbid runoff.
- Select BMPs depending on site characteristics (topography, drainage, soil type, ground cover, and critical areas) and the construction plan.
- Divert runoff away from exposed areas wherever possible. Keep clean water clean. Limit the extent of clearing operations and phase construction operations.
- Before re-seeding a disturbed soil area, amend all soils with compost wherever topsoil has been removed.
- Incorporate natural drainage features whenever possible, using adequate buffers and protecting areas where flow enters the drainage system.
- Minimize slope length and steepness.
- Reduce runoff velocities to prevent channel erosion.
- Prevent the tracking of sediment off-site.
- Select appropriate BMPs for the control of pollutants other than sediment.
- Be realistic about the limitations of controls that you specify and the operation and maintenance of those controls. Anticipate what can go wrong; how you can prevent it from happening; and what will need to be done to fix it.

A.2 Step-By-Step Procedure

A.2.1 Data Collection and Analysis

Consider the data collected to visualize the potential problems and limitations of the site. Determine which areas may have critical erosion hazards. The below factors should be considered in data analysis. Also evaluate existing site conditions and gather information that will help develop the most effective Construction SWPPP. The information gathered should be explained in the narrative and shown on the drawings.

Topography: Prepare a topographic drawing of the site to show the existing contour elevations at intervals of 12" to 5'-0" depending upon the slope of the terrain. The primary considerations are the slope steepness and length. The effect of runoff has a greater erosion potential with longer and steeper slopes. Erosion potential should be determined by a qualified engineer, soil professional or certified erosion control specialist.

Drainage: - Locate and clearly mark existing drainage swales and patterns on the drawing, including existing storm drain pipe systems. Natural drainage patterns that consist of overland flow, swales, and depressions should be used to convey runoff through the site to avoid constructing an artificial drainage system. Man-made ditches and waterways will become part of the erosion problem if they are not properly stabilized. Care should be taken to ensure that increased runoff from the site will not erode or flood the existing natural drainage system. Possible sites for temporary stormwater retention and detention should be considered. Construction should be directed away from areas of saturated soil - areas where groundwater may be encountered - and critical areas where drainage will concentrate. Preserve the natural drainage patterns on-site as much as possible.

Soils: Identify and label soil type(s) and erodibility (low, medium, high or an index value from the NRCS manual) on the drawing. Soils information can be obtained from a soil survey if one has been published for the county. If a soil survey is not available, a request can be made to a district Natural Resource Conservation Service Office.

Soils must be characterized for permeability, % organic matter, and effective depth by a qualified soil professional or engineer. These qualities should be expressed in averaged or nominal terms for the subject site or project. This information is frequently available in published literature. For example, the 1983 Soil Survey of Snohomish County lists the following information for each soil mapping unit or designation (e.g., a Sultan silt loam):

- a sieve analysis of the soils
- permeability (in/hr)
- available water-holding capacity (in/in)
- the percent of organic matter

Ground Cover: Label existing vegetation on the drawing. Such features as tree clusters, grassy areas, and unique or sensitive vegetation should be shown. Unique vegetation may include existing trees above a given diameter. Local requirements regarding tree preservation should be investigated. In addition, existing denuded or exposed soil areas should be indicated.

Ground cover is the most important factor in terms of preventing erosion. Existing vegetation that can be saved will prevent erosion better than any constructed BMP. Trees and other vegetation protect the soil structure. If the existing soil can NOT be saved, consider phasing construction, temporary seeding, and/or mulching.

Critical Areas: Delineate critical areas adjacent to or within the site on the drawing. Such features as steep slopes, streams, floodplains, lakes, wetlands, sole source aquifers, and geologic hazard areas, etc., should be shown. Delineate setbacks and buffer limits for these features on the drawings. Other related jurisdictional boundaries such as the Federal Emergency Management Agency (FEMA) base floodplain should also be shown on the drawings.

Other critical areas include (but are not limited to) flood hazard areas, mine hazard areas, slide hazard areas, sole source aquifers, wetlands, stream banks, fish-bearing streams, and other surface water bodies. Any critical areas within or adjacent to the development should exert a strong influence on the land development decisions. Critical areas and their buffers shall be delineated on the drawings and clearly marked in the field. Chain-link or other types of fencing may be more useful than just flagging the area(s) to ensure that equipment operators stay out of the critical areas. Only unavoidable work should occur within critical areas and their buffers. Unavoidable work will require special BMPs, permit restrictions, and mitigation plans.

Adjacent Areas: Identify existing buildings, roads, and facilities adjacent to or within the project site on the drawings. Identify existing and proposed utility locations, construction clearing limits and erosion and sediment control BMPs on the drawings. An analysis of adjacent properties should focus on areas upslope AND downslope from the construction project. Water bodies that will receive direct runoff from the site are a major concern. The types, values, and sensitivities of and risks of downstream resources such as private property, stormwater facilities, public infrastructure, or aquatic systems should be evaluated. Erosion and Sediment controls should be selected accordingly.

Existing Encumbrances: Identify wells, existing and abandoned septic drain field, utilities, and site constraints.

Precipitation Records: Determine the average monthly rainfall and rainfall intensity for the required design storm events. Make sure the on-site rain gauge is read for the precipitation after every rainfall event to compose the required rainfall records and verify the method of analysis for the design of the site BMPs.

A.2.2 Construction SWPPP Development and Implementation

After collecting and analyzing the data to determine the site limitations, the planner can then develop a Construction SWPPP. Each of the elements below must be considered and included in the Construction SWPPP unless site conditions render the element unnecessary and the exemption from that element is clearly justified in the narrative of the SWPPP.

Element #1: Mark Clearing Limits

Prior to beginning land disturbing activities, including clearing and grading, clearly mark all clearing limits, sensitive areas and their buffers, and trees that are to be preserved within the construction area. These shall be clearly marked, both in the field and on the plans, to prevent damage and offsite impacts. Plastic, metal, or stake wire fence may be used to mark the clearing limits.

Element #2: Establish Construction Access

- Construction vehicle access and exit shall be limited to one route, if possible; or two for linear projects such as roadways where more than one access is necessary for large equipment maneuvering. Access points shall be stabilized with a pad of quarry spalls or crushed rock prior to

traffic leaving the construction site to minimize the tracking of sediment onto public roads.

- Wheel wash or tire baths should be located on-site, if applicable.
- If sediment is tracked off-site, public roads shall be -at a minimum - cleaned thoroughly at the end of each day, or more frequently if necessary to prevent sediment from entering Waters of the State. Sediment shall be removed from roads by shoveling or pickup sweeping and shall be transported to a controlled sediment disposal area. Street washing will be allowed only AFTER sediment is removed in this manner.
- Street wash water shall be controlled by pumping back on site or otherwise be prevented from discharging into systems tributary to state surface waters.

Element #3: Control Flow Rates

- Properties and waterways downstream from development sites shall be protected from erosion due to increases in the volume, velocity, and peak flow rate of stormwater runoff from the project site, as required by local plan approval authority.
- Downstream analysis is necessary if changes in off-site flows could impair or alter conveyance systems, stream banks, bed sediment, or aquatic habitat. See Chapter 3 for off-site analysis guidelines.
- Where curb inlet protection is necessary, stormwater retention/detention facilities shall be constructed as one of the first steps in grading. Detention facilities shall be functional prior to construction of site improvements (e.g. impervious surfaces).
- The local permitting agency may require pond designs that provide additional or different stormwater flow control if necessary to address local conditions or to protect properties and waterways downstream from erosion due to increases in the volume, velocity, and peak flow rate of stormwater runoff from the project site.
- If permanent infiltration ponds are used for flow control during construction, these facilities should be protected from siltation during the construction phase.

Element #4: Install Sediment Controls

- Prior to leaving a construction site or prior to discharge to an infiltration facility, stormwater runoff from disturbed areas shall pass through a sediment pond or other appropriate sediment removal BMP. Runoff from fully stabilized areas may be discharged without a sediment removal BMP, but must meet the flow control performance standard of Element #3 above. Full stabilization means concrete or asphalt paving; coarse rock or native stone used as ditch lining; the use of rolled erosion products, a bonded fiber matrix product, or vegetative cover in a manner that will fully prevent soil erosion. The municipality shall inspect and approve areas fully stabilized by means other than pavement.
- Sediment ponds, vegetated buffer strips, sediment barriers or filters, dikes, and other BMPs intended to trap sediment on site shall be constructed as one of the first steps in grading. These BMPs shall be functional before other land disturbing activities take place.
- Earthen structures such as dams, dikes, and diversions shall be seeded and mulched according to the timing indicated in Element #5 below.

Element #5: Stabilize Soils

- All exposed and un-worked soils shall be stabilized by application of effective BMPs that protect the soil from the erosive forces of raindrop impact, flowing water, and wind.
- Soils shall be stabilized at the end of the shift before a holiday or weekend if needed based on the weather forecast.
- Applicable practices include, but are not limited to, temporary and permanent seeding; sodding; mulching; erosion control fabrics and matting; soil application of PAM; the early application of gravel base on areas to be paved; and dust control.
- Soil stabilization measures should be appropriate for the time of year, site conditions, estimated duration of use, and potential water quality impacts that stabilization agents may have on downstream waters or ground water.
- Soil stockpiles must be stabilized from erosion, protected with sediment trapping measures, and when possible, be located away from storm drain inlets, waterways and drainage channels.

- Linear construction activities, including right-of-way and easement clearing, roadway development, pipelines, and trenching for utilities, shall be conducted to meet the soil stabilization requirement. Contractors shall install the bedding materials, roadbeds, structures, pipelines, or utilities and re-stabilize the disturbed soils.

Element #6: Protect Slopes

- Design and construct cut and fill slopes in a manner that will minimize erosion.
- Consider soil type and its potential for erosion.
- Reduce slope runoff velocities by reducing continuous length of slope with terracing and diversions, reduce slope steepness, and roughen slope surface.
- Off-site stormwater (run-on) shall be diverted away from slopes and disturbed areas with interceptor dikes and/or swales. Off-site stormwater should be managed separately from stormwater generated on the site.
- At the top of slopes, collect drainage in pipe slope drains or protected channels to prevent erosion. Temporary pipe slope drains shall handle the peak flow from a 10 year, 24-hour design storm event. Consult the local drainage requirements for sizing permanent pipe slope drains.
- Provide drainage to remove ground water intersecting the slope surface of exposed soil areas.
- Excavated material shall be placed on the uphill side of trenches, consistent with safety and space considerations.
- Check dams shall be placed at regular intervals within channels that are cut down a slope.

Element #7: Protect Drain Inlets

- All storm drain inlets made operable during construction shall be protected so that stormwater runoff does not enter the conveyance system without first being filtered or treated to remove sediment.
- All approach roads shall be kept clean. Sediment and street wash water shall not be allowed to enter storm drains without prior and adequate treatment unless treatment is provided before the storm drain discharges to Waters of the State.
- Inlets should be inspected weekly at a minimum and daily during storm events. Inlet protection devices should be cleaned, removed, and/or replaced when sediment has filled one-third of the available storage (unless a different standard is specified by the product manufacturer).

Element #8: Stabilize Channels and Outlets

- All temporary on-site conveyance channels shall be designed, constructed and stabilized to prevent erosion from the expected peak 10-minute velocity of flow from a 10-year, 24-hour design storm for the developed condition.
- Stabilization, including armoring material, adequate to prevent erosion of outlets, adjacent stream banks, slopes, and downstream reaches shall provide at the outlets of all conveyance systems.

Element #9: Control Pollutants

- All pollutants, including waste materials and demolition debris, that occur on-site shall be handled and disposed of in a manner that does not cause contamination of stormwater.
- Maintenance and repair of heavy equipment and vehicles involving oil changes; hydraulic system drain down; solvent and de-greasing cleaning operations; fuel tank drain down and removal; and other activities which may result in discharge or spillage of pollutants to the ground or into stormwater runoff must be conducted using spill prevention measures, such as drip pans. Contaminated surfaces shall be cleaned immediately following any discharge or spill incident. Emergency repairs may be performed on-site using temporary plastic placed beneath and, if raining, over the vehicle.
- Wheel wash or tire bath wastewater shall be discharged to a separate on-site treatment system or to the sanitary sewer, if approved by that utility.
- Application of agricultural chemicals, including fertilizers and pesticides, shall be conducted in a manner and at application rates that will not result in loss of chemical to stormwater runoff. Manufacturers' recommendations for application rates and procedures shall be followed.
- BMPs shall be used to prevent or treat contamination of stormwater runoff by pH modifying sources. These sources include, but are not limited to, bulk cement, cement kiln dust, fly ash, new concrete washing and curing waters, waste streams generated from concrete grinding and sawing, exposed

aggregate processes, and concrete pumping and mixer washout waters. Stormwater discharges shall not cause or contribute to a violation of the water quality standard for pH in the receiving water.

- Construction sites with significant concrete work shall adjust the pH of stormwater if necessary to prevent violations of water quality standards.

Element #10: Control De-Watering

- Foundation, vault, and trench de-watering water, which have similar characteristics to stormwater runoff at the site, shall be discharged into a controlled conveyance system prior to discharge to a sediment trap or sediment pond.
- Clean, non-turbid de-watering water, such as well-point ground water, can be discharged to systems tributary to state surface waters, provided the de-watering flow does not cause erosion or flooding of receiving waters. These clean waters should not be routed through stormwater sediment ponds.
- Highly turbid or contaminated dewatering water from construction equipment operation, clamshell digging, concrete pour, or work inside a cofferdam, shall be handled separately from stormwater.
- Other disposal options, depending on site constraints, may include:
 1. infiltration;
 2. transport off-site in a vehicle, such as a vacuum flush truck, for legal disposal in a manner that does not pollute state waters;
 3. ADEQ approved on-site chemical treatment or other suitable treatment technologies;
 4. sanitary sewer discharge with local sewer district approval, if there is no other option; or
 5. use of a sedimentation bag with outfall to a ditch or swale for small volumes of localized dewatering.

Element #11: Maintain BMPs

- All temporary and permanent erosion and sediment control BMPs shall be maintained and repaired as needed to assure continued performance of their intended function. Maintenance and repair shall be conducted in accordance with BMP specifications.
- All temporary erosion and sediment control BMPs shall be removed within 30 days after final site stabilization is achieved or after the temporary BMPs are no longer needed. Trapped sediment shall be removed or stabilized on-site. Disturbed soil resulting from removal of BMPs or vegetation shall be permanently stabilized.

Element #12: Manage the Project

- Phasing of Construction.

Development projects shall be phased where feasible in order to prevent soil erosion and, to the maximum extent practicable, the transport of sediment from the site during construction. Re-vegetation of exposed areas and maintenance of that vegetation shall be an integral part of the clearing activities for any phase.

Clearing and grading activities for developments shall be permitted only if conducted pursuant to an approved site development plan (e.g., subdivision approval) that establishes permitted areas of clearing, grading, cutting, and filling. When establishing these permitted clearing and grading areas, consideration should be given to minimizing removal of existing trees and minimizing disturbance or compaction of native soils except as needed for building purposes. These permitted clearing and grading areas and any other areas required to preserve critical or sensitive areas, buffers, native growth protection easements, or tree retention areas as may be required by local jurisdictions, shall be delineated on the site plans and the development site.

- Coordination with Utilities and Other Contractors

The primary project proponent shall evaluate, with input from utilities and other contractors, the stormwater management requirements for the entire project, including the utilities, when preparing the Construction SWPPP.

- Inspection and Monitoring

All BMPs shall be inspected, maintained, and repaired as needed to assure continued performance of their intended function. Site inspections shall be conducted by a person who is knowledgeable in the principles and practices of erosion and sediment control. The person must have the skills to:

1. assess the site conditions and construction activities that could impact the quality of stormwater, and
2. assess the effectiveness of erosion and sediment control measures used to control the quality of stormwater discharges.

For construction sites 1 acre or larger that discharge stormwater to Waters of the State, a Certified Contractor's Site Official (CCSO - see BMP 140) shall be identified in the Construction SWPPP and shall be on-site or on-call at all times. Certification may be obtained through an approved training program that meets the erosion and sediment control training standards.

Whenever inspection and/or monitoring reveals that the BMPs identified in the Construction SWPPP are inadequate, due to the actual discharge of or potential to discharge a significant amount of any pollutant, appropriate BMPs or design changes shall be implemented as soon as possible.

- **Maintaining an Updated Construction SWPPP**

The Construction SWPPP shall be retained on-site or within reasonable access to the site. The SWPPP shall be modified whenever there is a change in the design, construction, operation, or maintenance at the construction site that has, or could have, a significant effect on the discharge of pollutants to Waters of the State.

The SWPPP shall be modified if, during inspections or investigations conducted by the owner/operator, or the applicable local or state regulatory authority, it is determined that the SWPPP is ineffective in eliminating or significantly minimizing pollutants in stormwater discharges from the site.

The SWPPP shall be modified as necessary to include additional or modified BMPs designed to correct problems identified. Revisions to the SWPPP shall be completed within seven (7) days following the inspection.

A.3 Construction SWPPP Requirements

The Construction SWPPP shall consist of two parts: a narrative and the drawings. The following two sections describe the contents of the narrative and the drawings. A checklist is included in Appendix G that can be used as a quick reference to determine if all the major items are included in the Construction SWPPP.

A.3.1 Narrative

- Describe the existing topography, vegetation, and drainage. Include a description of any structures or development on the parcel including the area of existing impervious surfaces.
- Describe adjacent areas, including streams, lakes, wetlands, residential areas, and roads that might be affected by the construction project. Provide a description of the downstream drainage leading from the site to the receiving body of water.
- Describe areas on or adjacent to the site that are classified as critical areas. Critical areas that receive runoff from the site shall be described up to ¼ mile away. The distance may be increased by the municipality. Describe special requirements for working near or within these areas.
- Describe areas on the site that have potential erosion problems.
- Describe the intended sequence and timing of construction activities any proposed construction phasing.
- Describe the construction schedule. If the schedule extends into the wet season, describe what activities will continue during the wet season and how the transport of sediment from the construction site to receiving waters will be prevented.
- Engineering calculations must bear the signature and stamp of an engineer licensed in the state of Arkansas.
- A responsible, certified erosion control specialist shall be identified. All telephone, fax, and/or pager numbers should be included along with email addresses.

A.3.2 Drawings

- Provide a map with enough detail to identify the location of the construction site; adjacent roads; and receiving waters.
- Provide a site map(s) showing the following features. The site map requirements may be met using multiple plan sheets for ease of legibility.

1. A legal description of the property boundaries or an illustration of property lines (including distances) in the drawings.
2. The direction of north in relation to the site.
3. Existing structures and roads, if present.
4. The boundaries of and label the different soil types.
5. Areas of potential erosion problems.
6. Any on-site and adjacent surface waters, critical areas, their buffers, FEMA base flood boundaries, and Shoreline Management boundaries.
7. Existing contours and drainage basins and the direction of flow for the different drainage areas.
8. Final and interim grade contours as appropriate, drainage basins, and the direction of stormwater flow during and upon completion of construction.
9. Areas of soil disturbance, including all areas affected by clearing, grading and excavation.
10. Locations where stormwater discharges to surface waters during and upon completion of construction.
11. Existing unique or valuable vegetation and the vegetation that is to be preserved.
12. Cut and fill slopes indicating top and bottom of slope catch lines.
13. Stockpile, waste storage, and vehicle storage/maintenance areas.
14. Total cut and fill quantities and the method of disposal for excess material
- Show on the site map the following temporary and permanent conveyance features:
 1. Locations for swales, interceptor trenches, or ditches.
 2. Drainage pipes, ditches, or cut-off trenches associated with erosion and sediment control and stormwater management.
 3. Temporary and permanent pipe inverts and minimum slopes and cover.
 4. Grades, dimensions, and direction of flow in all ditches and swales, culverts, and pipes.
 5. Details for bypassing off-site runoff around disturbed areas.
 6. Locations and outlets of any dewatering systems.
- Show on the site map the locations of stormwater detention BMPs.
- Show on the site map all major structural and nonstructural ESC BMPs including:
 1. The location of sediment pond(s), pipes and structures.
 2. Dimension pond berm widths and inside and outside pond slopes.
 3. The trap/pond storage required and the depth, length, and width dimensions.
 4. Typical section views through pond and outlet structure.
 5. Typical details of gravel cone and standpipe, and/or other filtering devices.
 6. Stabilization technique details for inlets and outlets
 7. Control/restrictor device location and details.
 8. Stabilization practices for berms, slopes, and disturbed areas.
 9. Rock specifications and detail for rock check dam, if used.
 10. Spacing for rock check dams as required.
 11. Front and side sections of typical rock check dams.
 12. The location, detail, and specification for silt fence.
 13. The construction entrance location and a detail.
- Indicate on the site map the water quality sampling locations, if required by the local, state, or federal permitting authority. Sampling stations shall be located in accordance with applicable permit requirements
- Standard notes are suggested in Appendix C.
- Notes addressing construction phasing and scheduling shall be included on the drawings.

Appendix B: Low-Impact Development

- B.1 Site & Design Considerations
 - B.1.1 Landscaping and Vegetative Control Practices
 - B.1.2 Infiltration Techniques
 - B.1.3 Impervious Surface Area Reduction
- B.2 Costs
- B.3 Maintenance, Landscaping, and Vegetative Control Practices
- B.4 Infiltration Techniques
- B.5 Impervious Surface Area Reduction
- B.6 Undisturbed Water Body Buffer

B.1 Site & Design Considerations

B.1.1 Landscaping and Vegetative Control Practices

Landscaping and vegetative control practices can be applied to any land use type, but the following site-specific criteria should be considered to properly select a plant species or landscape options:

- Climate
- Topography
- Soil Types
- Wind exposure
- Soil drainage and moisture conditions
- Available light or shade tolerance
- Planned use of the area
- Degree of maintenance desired
- Planting season

Certain criteria may be targeted for landscaping and vegetative control practices for their added stabilization benefits or support of other BMPs. Targeted areas may include:

- Steep slopes
- Drainage channels with natural cover
- Streams and creeks
- Areas connected to catch basins
- Buffer zones
- Use in conjunction with various structural BMPs (i.e. detention/retention ponds, wetlands, swales, etc.)

B.1.2 Infiltration Techniques

Design is suitable for nearly all residential, commercial or industrial lots.

- Storage Practices
- Development density can be clustered to leave areas with soils that have high infiltration rates undisturbed.
- Where possible, disconnect rooftop downspouts from pervious surfaces to drain over vegetative filter strips.
- Cisterns and rain barrels have the fewest site constraints.
- Design and use should have some contingency for overflow or freezing.
- Best suited for applications with an interest in re-using the water.
- Pre-treatment usually requires a wire mesh filter at the top of the cistern or barrel.
- Infiltration
- Bio-retention and grassed swales are common infiltration techniques.
- Design and use should consider the peak flow demands, topography, and soil types.
- In areas where local soils do not readily support infiltration, sand filtration systems can be used to

- discharge treated stormwater to a stream or storm sewer.
- Rain Gardens
 - Rain gardens are landscaped bio-retention facilities that soak up runoff displaced by the impervious area of a structure. Runoff is trapped during a storm event, infiltrating slowly into the soil where it is treated by vegetation and microbes. Rain gardens can increase the aesthetic qualities of a development, and offer a greater benefit than traditional gardens. Rain gardens can have substantial environmental and water quality benefits.
 - Infiltration requires layers of soil, sand and organic mulch. In areas where local soils do not readily support infiltration, rain gardens can be modified to be underlain with a sand filtration system and under drain that discharges treated stormwater to a storm sewer.
 - Rain garden vegetation should include indigenous plants and can be integrated into current or future landscaping using grasses, ferns or flowering plants.
 - Rain gardens should be at least 10'-0" away from a structure to prevent groundwater seepage into the foundation. Rain gardens should be built level into a gentle slope that drains runoff. Additionally, rain gardens preferably should not be placed in right-of-way.
 - Do not place rain garden directly over septic systems. Build in areas of full or partial sun. For more information, visit <http://www.stormwatercenter.net>

B.1.3 Impervious Surface Area Reduction

Applying techniques to reduce the impervious surface area of new development and re-development is often dependent on the applicability, cost, and maintenance of those techniques. Alternative roadway layouts and reduction of parking spaces should be considered to reduce overall imperviousness. Green Parking techniques reduce the impervious area of parking lots and consequently, the amount of stormwater runoff. Likewise, Green Rooftop reduces the impervious area of rooftops and consequently, the amount of stormwater runoff.

Green Parking techniques include:

- Shared parking in mixed use areas and structured parking.
- Building additional parking upwards or downwards (i.e. parking garages). Design around average parking demands instead of conventional parking requirements. Provide an overflow lot utilizing grass or alternative pavers for peak demand parking. For more on alternatives, visit <http://www.stormwatercenter.net>
- Minimizing parking space dimensions by reducing the length and width of spaces.
- Parking areas restricted to compact cars.
- Incorporate bio-retention areas in parking lot design to effectively treat stormwater runoff.

Green Rooftop is a layer of vegetation, shrubs, or trees planted on rooftops to absorb stormwater runoff.

- In the summer, Green Rooftops retain approximately 70% to 100% of the precipitation that falls on them. In the winter, they retain approximately 40% to 50%. A green rooftop generally consists of:
- A waterproofing membrane
 - Insulation
 - Protection layer
 - Drainage layer
 - Filter mat
 - Soil layer
 - Vegetation
 - The load-bearing capacity of the rooftop should be identified prior to green rooftop design. It is recommended to consult a structural engineer before designing or installing a green rooftop. If the projected live load of a green rooftop is greater than 17 lbs per square foot, consultation with a structural engineer is required
 - An internal drainage network that directs flow away from the roof to inhibit ponding should be included in the design.
 - Green rooftops can be successfully built on slopes up to 30 degrees.
 - Other things pervious surfaces can do:

- Filter pollutants from stormwater runoff or groundwater.
- Recycle carbon dioxide into oxygen.
- Provide shade along waterways and sustain the integrity of stream ecosystems and habitats.

Forestry is commonly used as an aquatic buffer. The benefits of buffers are increased in a forested condition.

B.2 Costs

Low-impact development costs vary depending on the application, area, and land use. A few general guidelines used to estimate costs are listed below.

- Approximately \$100 for a rain barrel and up to \$200 for a dry well.
- Infiltration areas cost about \$6.40 per cubic foot of quality treatment.
- Initial costs of a green roof can be 30% greater than a conventional roof. However, long-term maintenance and energy costs savings can offset initial costs and increase the lifespan by as much as 50%. Green rooftops can be warranted up to 15 years.

B.3 Maintenance Landscaping and Vegetative Control Practices

- Irrigation, fertilization, and mulching are variable maintenance practices dependant on the plant species, soil conditions, and topography.
- Established vegetation and landscaping may need periodic seasonal trimming to maintain aesthetic appearance.
- Mow or weed as necessary.

B.4 Infiltration Techniques

- Practices require frequent, but small efforts to maintain, such as draining a rain barrel after a large wet weather event; cleaning debris out of the infiltration practices; or keeping the vegetation in the rain garden from overgrowing. Weeding and watering will be needed in the first 2 years of establishing a rain garden, and thinning of plants in the following years as they mature.
- Maintenance is dependent on the owner's efforts. Can be maintained by commercial landscaping firms.

B.5 Impervious Surface Area Reduction

- Alternative pavers generally have a moderate cost of maintenance associated with them and snow removal can be difficult.
- Clear debris or blockage from internal drainage network to prevent overflow and ponding on green roofs.
- Established vegetation on green roofs may need periodic seasonal trimming to maintain aesthetic appearance.

B.6 Undisturbed Water Body Buffer

- Established vegetation, shrubs and trees may need periodic seasonal trimming or pruning to maintain aesthetic appearance.

Appendix C: Standard Comments

The following standard notes are suggested for use in erosion control plans. Local jurisdictions may have other mandatory notes for construction plans that are applicable. Plans should identify with phone numbers the person or firm responsible for the preparation of and maintenance of the erosion control plan.

Standard Notes

- Approval of this ESC plan does not constitute an approval of permanent road or drainage design (e.g. size and location of roads, pipes, restrictors, channels, retention facilities, utilities, etc.).
- The implementation of the ESC plans and the construction, maintenance, replacement, and upgrading of the ESC facilities is the responsibility of the applicant/contractor until all construction is completed and approved and vegetation/landscaping is established. The boundaries of the clearing limits shown on the plan shall be clearly flagged in the field prior to construction. During the construction period, no disturbance beyond the flagged clearing limits shall be permitted. The flagging shall be maintained by the applicant/contractor for the duration of construction.
- The ESC facilities shown on the plan must be constructed in conjunction with all clearing and grading activities, and in such a manner as to insure that sediment and sediment-laden water do not enter the drainage system, roadways, or violate applicable water standards.
- The ESC facilities shown on the plan are the minimum requirements for anticipated site conditions. During the construction period, the ESC facilities shall be upgraded as needed for unexpected storm events and to ensure that sediment and sediment-laden water do not leave the site.
- The ESC facilities shall be inspected daily by the applicant/contractor and maintained as necessary to ensure their continued functioning.
- The ESC facilities on in-active sites shall be inspected and maintained a minimum of once a month and within 48 hours following any storm event.
- At no time shall more than 12" of sediment be allowed to accumulate. All catch basins and conveyance lines shall be cleaned prior to paving. The cleaning operation shall not flush sediment-laden water into the downstream system.
- Stabilized construction entrances shall be installed at the beginning of construction and maintained for the duration of the project. Additional measures may be required to insure that all paved areas are kept clean for the duration of the project.

Appendix D: Information on Chemical Treatments

D.1 Chemical Treatments for Turbidity Reduction

D.1.1 Coagulation

D.1.2 Flocculation

D.1.3 Clarification

D.2 Coagulants

D.3 Application Considerations

D.4 Mixing in Coagulants & Flocculation

D.5 Polymer Batch Treatment

D.6 Adjustment of pH and Alkalinity

D.1 Chemical Treatment for Turbidity Reduction

Coagulation and flocculation have been used for over a century to treat water. It is used less frequently for the treatment of wastewater. The use of coagulation and flocculation for treating stormwater is a very recent application. Experience with the treatment of water and wastewater has resulted in a basic understanding of the process, in particular factors that affect performance. This experience can provide insights as to how to most effectively design and operate similar systems in the treatment of stormwater.

Fine particles suspended in water give it a milky appearance, measured as turbidity. Their small size, often much smaller than 1.00 μm in diameter, gives them a very large surface area relative to their volume. These fine particles typically carry a negative surface charge. Largely because of these two factors - small size and negative charge - these particles tend to stay in suspension for extended periods of time; thus, removal is not practical by gravity settling. These are called stable suspensions. Polymers, as well as inorganic chemicals such as alum, speed the process of clarification. The added chemical destabilizes the suspension and causes the smaller particles to agglomerate. The process consists of three steps: coagulation, flocculation, and settling or clarification. Each step is explained below as well as the factors that affect the efficiency of the process.

D.1.1 Coagulation:

Coagulation is the first step. It is the process by which negative charges on the fine particles that prevent their agglomeration are disrupted. Chemical addition is one method of destabilizing the suspension, and polymers are one class of chemicals that are generally effective. Chemicals that are used for this purpose are called coagulants. Coagulation is complete when the suspension is destabilized by the neutralization of the negative charges.

Coagulants perform best when they are thoroughly and evenly dispersed under relatively intense mixing. This rapid mixing involves adding the coagulant in a manner that promotes rapid dispersion, followed by a short time period for destabilization of the particle suspension. The particles are still very small and are not readily separated by clarification until flocculation occurs.

D.1.2 Flocculation:

Flocculation is the process by which fine particles that have been destabilized bind together to form larger particles that settle rapidly. Flocculation begins naturally following coagulation, but is enhanced by gentle mixing of the destabilized suspension. Gentle mixing helps to bring particles in contact with one another such that they bind and continually grow to form "flocs." As the size of the floc increases they become heavier and tend to settle more rapidly.

D.1.3 Clarification:

The final step is the settling of the particles. Particle density, size and shape are important during settling. Dense, compact floc settles more readily than less dense, fluffy floc. Because of this, flocculation to form dense, compact floc is particularly important during water treatment. Water temperature is also important during settling. Both the density and viscosity of water are affected by temperature, which in turn affect settling.

Cold temperatures increase viscosity and density, thus slowing down the rate at which the particles settle.

The conditions under which clarification is achieved can affect performance. Currents can affect settling. Currents can be produced by wind; by differences between the temperature of the incoming water and the water in the clarifier; and by flow conditions near the inlets and outlets. Quiescent water such as that which occurs during batch clarification provides a good environment for effective performance as many of these factors become less important in comparison to typical sedimentation basins. One source of currents that is likely important in batch systems is movement of the water leaving the clarifier unit. Given that flocs are relatively small and light the exit velocity of the water must be as low as possible. Sediment on the bottom of the basin can be re-suspended and removed by fairly modest velocities.

D.2 Coagulants:

Polymers are large organic molecules that are made up of sub-units linked together in a chain-like structure.

Attached to these chain-like structures are other groups that carry positive or negative charges, or have no charge. Polymers that carry groups with positive charges are called cationic; those with negative charges are called anionic; and those with no charge (neutral) are called non-ionic.

Cationic polymers can be used as coagulants to destabilize negatively charged turbidity particles present in natural waters, wastewater and stormwater. Aluminum sulfate (alum) can also be used as this chemical becomes positively charged when dispersed in water. In practice, the only way to determine whether a polymer is effective for a specific application is to perform preliminary or on-site testing.

Polymers are available as powders, concentrated liquids, and emulsions (which appear as milky liquids). The latter are petroleum-based, which are not allowed for construction stormwater treatment. Polymer effectiveness can degrade with time and also from other influences. Thus, manufacturers' recommendations for storage should be followed. Manufacturer's recommendations usually do not provide assurance of water quality protection or safety to aquatic organisms. Consideration of water quality protection is necessary in the selection and use of all polymers.

D.3 Application Considerations:

Application of coagulants at the appropriate concentration or dosage rate for optimum turbidity removal is important for management of chemical cost, for effective performance, and to avoid aquatic toxicity. The optimum dose in a given application depends on several site-specific features. Turbidity of untreated water can be important with turbidities greater than 5,000 NTU. The surface charge of particles to be removed is also important. Environmental factors that can influence dosage rate are water temperature, pH, and the presence of constituents that consume or otherwise affect polymer effectiveness. Laboratory experiments indicate that mixing previously settled sediment (floc sludge) with the untreated stormwater significantly improves clarification, therefore reducing the effective dosage rate. Preparation of working solutions and thorough dispersal of polymers in water to be treated is also important to establish the appropriate dosage rate.

For a given water sample, there is generally an optimum dosage rate that yields the lowest residual turbidity after settling. When dosage rates below this optimum value (under-dosing) are applied, there is an insufficient quantity of coagulant to react with, and therefore destabilize, all of the turbidity present. The result is residual turbidity (after flocculation and settling) that is higher than with the optimum dose. Over-dosing, application of dosage rates greater than the optimum value, can also negatively impact performance. Again, the result is higher residual turbidity than that with the optimum dose.

D.4 Mixing in Coagulation/Flocculation:

The G-value, or "G", is a measure of the mixing intensity applied during the coagulation and flocculation processes. The symbol G stands for the "velocity gradient," which is related in part to the degree of turbulence generated during mixing. High G-values mean high turbulence, and vice versa. High G-values provide the best conditions for coagulant addition. With high G's, turbulence is high and coagulants are rapidly dispersed to their appropriate concentrations for effective destabilization of particle suspensions. Low G-values provide the best conditions for flocculation. Here, the goal is to promote formation of dense, compact floc that will settle readily. Low G provides low turbulence to promote particle collisions

so that floc can form. Low G also generates sufficient turbulence such that collisions are effective in floc formation, but does not break up floc that has already formed.

Design engineers wishing to review more detailed presentations on this subject are referred to the following textbooks.

- Fair, G., J. Geyer and D. Okun, *Water and Wastewater Engineering*, Wiley and Sons, NY, 1968.
- American Water Works Association, *Water Quality and Treatment*, McGraw-Hill, NY, 1990.
- Weber, W.J., *Physicochemical Processes for Water Quality Control*, Wiley and Sons, NY, 1972.

D.5 Polymer Batch Treatment Process Description:

Stormwater is collected at interception point(s) on-site and is diverted by gravity or pumping to a storage pond or other holding area. The stormwater is stored until treatment occurs. It is important that the holding pond be large enough to provide adequate storage.

The first step in the treatment sequence is to check the pH of the stormwater in the storage pond. The pH is adjusted by the application of acid or base until the stormwater in the storage pond is within the desired pH range. When used, acid is added immediately downstream of the transfer pump. Typically sodium bicarbonate (baking soda) is used as a base, although other bases may be used. When needed, base is added directly to the storage pond. The stormwater is re-circulated with the treatment pump to provide mixing in the storage pond. Initial pH adjustments should be based on daily bench tests. Further pH adjustments can be made at any point in the process. Once the stormwater is within the desired pH range, the stormwater is pumped from the storage pond to a treatment cell as polymer is added. The polymer is added upstream of the pump to facilitate rapid mixing.

After polymer addition, the water is kept in a lined treatment cell for clarification of the sediment-floc. In a batch-mode process, clarification typically takes from 30 minutes to several hours. Prior to discharge, samples are collected for analysis of pH and turbidity. If both are acceptable, the treated water is discharged.

Several configurations have been developed to discharge treated water from the treatment cell. The original configuration is a device that withdraws the treated water from just beneath the water surface using a float with adjustable struts that prevent the float from settling on the cell bottom. This reduces the possibility of picking up sediment-floc from the bottom of the pond. The struts are usually set at a minimum clearance of about 12"; that is, the float will come within 12" of the bottom of the cell. Other systems have used vertical guides or cables which constrain the float, allowing it to drift up and down with the water level. More recent designs have an H-shaped array of pipes, set on the horizontal. This scheme provides for withdrawal from 4 points rather than a single location. This configuration reduces the likelihood of sucking settled solids from the bottom. It also reduces the tendency for a vortex to form. Inlet diffusers, a long floating or fixed pipe with many small holes in it, are also an option.

Safety is a primary concern. Design should consider the hazards associated with operations, such as sampling. Facilities should be designed to reduce slip hazards and drowning. Tanks and ponds should have life rings, ladders, or steps extending from the bottom to the top.

D.6 Adjustment of the pH and Alkalinity:

The pH must be in the proper range for the polymers to be effective, which is 6.5 to 8.5 for Calgon CatFloc 2953, the most commonly used polymer. As polymers tend to lower the pH, it is important that the stormwater have sufficient buffering capacity. Buffering capacity is a function of alkalinity. Without sufficient alkalinity, the application of the polymer may lower the pH to below 6.5. A pH below 6.5 not only reduces the effectiveness of the polymer, it may create a toxic condition for aquatic organisms. Stormwater may not be discharged without readjustment of the pH to above 6.5. The target pH should be within 0.2 standard units of the receiving water pH.

Experience gained at several projects has shown that the alkalinity needs to be at least 50 mg/L to prevent a drop in pH to below 6.5 when the polymer is added. Baking soda has been used to raise both the alkalinity and the pH. Although lime is less expensive than baking soda, if over-dosed lime can raise the pH above 8.5; thus requiring a downward adjustment for the polymer to be effective. Baking soda has the advantage of not raising the pH above 8.3 regardless of the amount that is added. Experience

indicates that the amount of baking soda sufficient to raise the alkalinity to above 50 mg/L produces a pH near neutral or 7.

Alkalinity cannot be easily measured in the field. Therefore, conductivity, which can be measured directly with a hand-held probe, has been used to ascertain the buffering condition. It has been found through local experience that when the conductivity is above 100 $\mu\text{S}/\text{cm}$, the alkalinity is above 50 mg/L. This relationship may not be constant and therefore care must be taken to define the relationship for each site.

Experience has shown that the placement of concrete has a significant effect on the pH of construction stormwater. If the area of fresh exposed concrete surface is significant, the pH of the untreated stormwater may be considerably above 8.5. Concrete equipment wash water shall be controlled to prevent contact with stormwater. Acid may be added to lower the pH to the background level pH of the receiving water.

The amount of acid needed to adjust the pH to the desired level is not constant but depends upon the polymer dosage, and the pH, turbidity, and alkalinity of the untreated stormwater. The acid commonly used is sulfuric although muriatic and ascorbic acids have been used. Pelletized dry ice has also been used and reduces the safety concerns associated with handling acid.

Appendix E: Sample Construction SWPPP Checklist

Project Name: _____

Construction SWPPP Reviewer: _____ Review Date: _____

Section I – Construction SWPPP Narrative

1. Construction Stormwater Pollution Prevention Elements

- A. Describe how each of the Construction Stormwater Pollution Prevention Elements has been addressed though the Construction SWPPP. _____
- _____
- B. Identify the type and location of BMPs used to satisfy the required element. _____
- _____
- C. Written justification identifying the reason an element is not applicable to the proposal. _____
- _____

12 Required Elements-Construction Stormwater Pollution Prevention Plan

- | | |
|-----------------------------|----------------------------------|
| 1. Mark Limits _____ | 7. Protect Inlets _____ |
| 2. Establish Access _____ | 8. Stabilize Paths/Outlets _____ |
| 3. Control Flow Rates _____ | 9. Control Pollutants _____ |
| 4. Install Controls _____ | 10. Control De-Watering _____ |
| 5. Stabilize Soils _____ | 11. Maintain BMPs _____ |
| 6. Protect Slopes _____ | 12. Manage the Project _____ |

2. Project Description

- A. Total project area _____
- B. Total proposed impervious area _____
- C. Total proposed area to be disturbed, also off-site borrow and fill areas _____
- D. Total volumes of proposed cut and fill _____

3. Existing Site Conditions

- A. Description of the existing topography _____
- B. Description of the existing vegetation _____
- C. Description of the existing drainage _____

4. Adjacent Areas

- A. Description of adjacent areas which may be affected by site disturbance

Streams/Creeks _____	Residential Areas _____
Lakes _____	Roads _____
Mitigated Wetlands _____	Pedestrian/Trail Paths _____
Floodway/Floodplain _____	Other _____
- B. Description of the downstream drainage path leading from the site to the receiving body of water. (Minimum distance of 400 yards.) _____

5. Critical Areas

- A. Description of critical areas on or adjacent to the site. _____
- _____
- B. Description of special requirements for working in or near critical areas. _____
- _____

6. On-site Soils

- A. Soil name(s) _____
- B. Soil mapping unit _____
- C. Erodibility _____
- D. Settleability _____
- E. Permeability _____
- F. Depth _____
- G. Texture _____
- H. Soil Structure _____

7. Erosion Problem Areas

Description of potential erosion problems on site _____

8. Construction Phasing

- A. Construction sequence _____
- B. Construction phasing (if proposed) _____

9. Construction Schedule

- A. Provide a proposed construction schedule _____
- B. Wet Season Construction Activities
 - 1. Proposed wet season activities _____
 - 2. Proposed wet season restraints for sensitive/critical areas _____

10. Financial/Ownership Responsibilities

- A. Identify the property owner responsible for the initiation of bonds and/or other financial securities. _____
- B. Describe bonds and/or other evidence of financial responsibility for liability associated with erosion and sedimentation impacts. _____

11. Engineering Calculations (Provide Design Calculations)

- A. Sediment Ponds/Traps _____
- B. Diversions _____
- C. Waterways _____
- D. Runoff/Stormwater Detention Calculations _____

Section II - Erosion and Sediment Control Plans

1. General

- A. Vicinity Map _____
- B. City of _____ Approval Block _____
- C. Erosion and Sediment Control Notes _____

2. Site Plan

- A. Legal description of subject property _____
- B. North Arrow _____
- C. Boundaries of existing vegetation, e.g. tree lines, pasture areas, etc. _____
- D. Areas of potential erosion problems _____
- E. On-site or adjacent surface waters, critical areas and associated buffers _____
- F. FEMA base flood boundaries and other related boundaries _____
- G. Existing and proposed contours _____
- H. Drainage basins and direction of flow for individual drainage areas _____

- I. Final contours and identify developed condition drainage basins _____
- J. Delineate areas that are to be cleared and graded _____
- K. Show all cut and fill slopes indicating top and bottom of slope catch lines _____

3. Conveyance Systems

- A. Locations for swales, interceptor trenches, or ditches _____
- B. All temporary and permanent pipes, ditches, or cut-offs required for ESC _____
- C. Minimum slope and cover for all pipes or pipe inverts _____
- D. Grades, dimensions, and direction of flow _____
- E. Details for bypassing off-site runoff around disturbed areas _____
- F. Locations and outlets of dewatering systems _____

4. Location of Detention BMPs _____

5. Erosion and Sediment Control Facilities

- Locations of sediment traps, ponds, pipes and structures _____
- Dimension pond berm widths and slopes _____
- Trap/pond storage required and the depth, length, & width dimensions _____
- Typical section views through pond and outlet structure _____
- Typical details of gravel cone and standpipe, and/or other filters _____
- Stabilization techniques for outlet/inlet _____
- Control/restrictor device location and details _____
- Specify cover of berms and slopes _____
- Rock specifications and detail for rock check dams; Specify spacing _____
- Front and side sections of typical rock check dams _____
- Locations and details and specifications for silt fabric _____
- Construction entrance location and detail _____

6. Detailed Drawings

Any practices used that are not referenced by city code or regulation should be explained and illustrated with detailed drawings. _____

7. Other Pollutant BMPs

Indicate on the site plan the location of BMPs to be used for the control of pollutants other than sediment, e.g. concrete wash water. _____

8. Monitoring Locations

Indicate on the site plan the water quality sampling locations to be used for monitoring water quality on the construction site, if applicable. _____

Appendix F: Minimum Requirements for Training Course

- F.1 General Requirements
- F.2 Required Course Elements
- F.3 Instructor Qualifications

F.1 General Requirements

1. The course shall teach the construction stormwater pollution prevention guidance provided in the most recent version of:
 - A. CPESC, CESSWI, CSI or other Stormwater Erosion and Sediment Control certified courses, or
 - B. Other equivalent stormwater management manuals approved by the state.
2. Upon completion of course, each attendee shall receive documentation of training that states completion of the course.
3. The initial training course shall be a minimum of 6 hours (with a reasonable time allowance for lunch and breaks) and include field elements (may be by photo or video). The field elements must familiarize students with the proper installation, maintenance and inspection of common erosion and sediment control BMPs including, but not limited to: blankets, check dams, silt fence, straw mulch, plastic, and seeding.
4. The refresher course shall be a minimum of 4 hours.
 - A. The refresher course shall include:
 - Applicable updates to the Stormwater Management Manual that is used to teach the course, including new or updated BMPs; **AND**
 - Applicable changes to the NPDES General Permit for Construction Activities.
 - B. The refresher course may be taught using an alternative format (e.g. internet, CD ROM, etc.) if the module is approved by State.

F.2 Required Course Elements

1. Erosion and Sedimentation Impacts
 - Examples and case studies
2. Erosion and Sedimentation Processes
 - A. Definitions
 - B. Types of erosion
 - C. Sedimentation
 - Basic settling concepts
 - Problems with clays/turbidity
3. Factors Influencing Erosion Potential
 - A. Soil
 - B. Vegetation
 - C. Topography
 - D. Climate
4. Regulatory Requirements
 - A. NPDES - Construction Stormwater General Permit
 - B. Local requirements and permits
 - C. Other regulatory requirements
5. Stormwater Pollution Prevention Plan (SWPPP)
 - A. SWPPP is a living document – should be revised as necessary
 - B. 12 Elements of a SWPPP; discuss suggested BMPs (with examples)

<ul style="list-style-type: none"> • Mark Clearing Limits • Establish Construction Access • Control Flow Rates • Install Sediment Controls 	<ul style="list-style-type: none"> • Stabilize Soils • Protect Slopes • Protect Drain Inlets • Stabilize Channels and Outlets 	<ul style="list-style-type: none"> • Control Pollutants • Control De-watering • Maintain BMPs • Manage the Project
--	---	--

6. Monitoring, Reporting, & Record-keeping
 - A. Site inspections/visual monitoring
 - Disturbed areas
 - BMPs
 - Stormwater discharge points
 - B. Water quality sampling & analysis
 - Turbidity
 - pH
 - C. Monitoring frequency
 - Set by NPDES permit
 - Inactive sites - reduced frequency
 - D. Adaptive Management
 - When problem is indicated, take appropriate action (e.g. install/maintain BMPs)
 - Document the corrective action(s) in SWPPP
 - E. Reporting
 - Inspection reports & checklists
 - Non-compliance notification
 - Discharge Monitoring Reports (DMR)

F.3 Instructor Qualifications

1. Instructors must be qualified to effectively teach the required course elements.
2. At a minimum, instructors must have:
 - A. Current certification as a Certified Professional in Erosion and Sediment Control (CPESC), Certified Erosion, Sediment, and Storm Water Inspector (CESSWI), Certified Professional in Storm Water Quality (CPSWQ), or Certified MS4 Specialist (CMS4S); **OR**
 - B. Completed a training program for teaching the required course elements, **OR**
 - C. The academic credentials and instructional experience necessary for teaching the required course elements.
3. Instructors must demonstrate competent instructional skills and knowledge of the applicable subject matter.